

RADIO'S LIVEST MAGAZINE



October
25 Cents
Canada 30¢

Radio-Craft

HUGO GERNSBACK Editor

How to Build
An Ultra-Modern
9-Tube Superheterodyne

See Page 202



Reactivating Oxide-Filament Tubes—A Modern Reflex Radio Set
Tuning Meters—A Portable S.-W. Test Lab.—Tube Adapters

SPEED

SPEED

SPEED



EFFICIENCY!!

*Ever the Goal of the Progressive
Manufacturer*

EFFICIENCY!!

*Ever the Need of the
Service Man*

EFFICIENCY!!

*Ever Necessary to
Flawless Reception
in the Home.*

SPEED

**Gives this and more....With
Radio's Premier Tube Developments**

**TRIPLE-TWIN • TELEVISION • FOTO-LECTRIC
TUBES**

*Write for latest free bulletins—Turn to Page 256A
for our Card—Keep up with progress by contact with*

SPEED!

CABLE RADIO TUBE CORP.
230-240 NO. NINTH ST. BROOKLYN, N.Y.

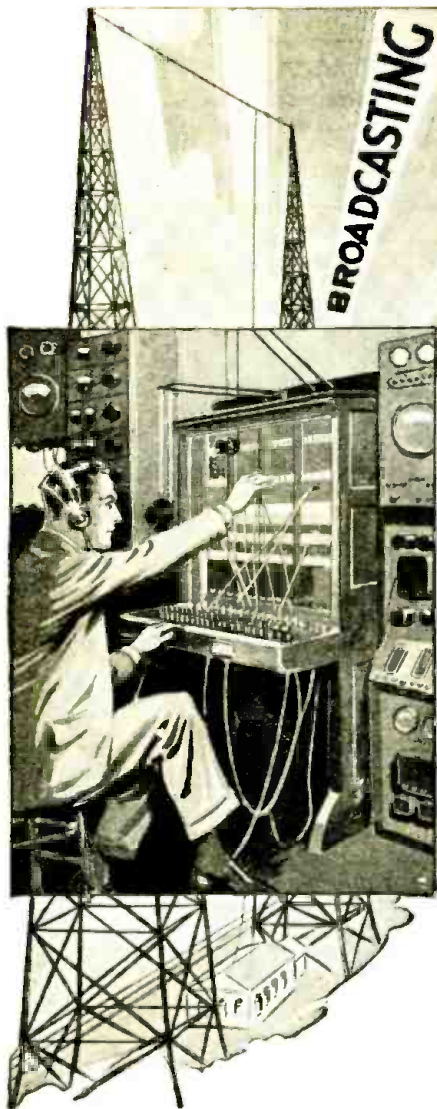

BROADCASTING

TELEVISION

TALKING PICTURES

WIRELESS OPERATING

WIN FAME and FORTUNE in **RADIO!**

Don't spend your life slaving away in some dull, hopeless job! Don't be satisfied to work for a mere \$20 or \$30 a week. Let me show you how to make money in Radio—the fastest-growing, biggest field on earth!

JOBS LEADING TO SALARIES OF \$50 A WEEK AND UP!

Jobs as Designer, Inspector and Tester—as Radio Salesman and in Service and Installation Work—as operator or Manager of a Broadcasting Station—as Wireless Operator on a Ship or Airplane, as a Talking Picture or Sound Expert—HUNDREDS of OPPORTUNITIES for fascinating, well-paid Jobs!

10 Weeks of Shop Training At Coyne in Chicago

You are given a thorough training in Radio at Coyne—in 10 short, pleasant weeks by actual work on real Radio, Television and Sound equipment. We don't waste time on useless theory. We give you the practical training you will need.

All Practical Work at Coyne

You are not trained by book study at Coyne. We train you on a great outlay of Radio, Television and Sound equipment—on scores of modern Radio Receivers, huge Broadcasting equipment, the very latest Television apparatus, Talking Picture and Sound Reproduction equipment, Code Practice equipment, etc. You don't need advanced education or previous experience. We give

you—right here in the Coyne Shops—the actual practice and experience you'll need.

TELEVISION Is Now Here!

And TELEVISION is already here! Soon there'll be a demand for THOUSANDS of TELEVISION EXPERTS! The man who learns Television NOW can have a real future in this great new field. Get in on the ground-floor of this amazing new Radio development! Learn Television at COYNE on the very latest, newest Television equipment.

Talking Pictures A Great Field

Talking Pictures and Public Address Systems offer thousands of golden opportunities to the Trained Radio

man. Here is a great new field of Radio that has just started to grow! Prepare NOW for these marvelous opportunities! Learn Radio Sound Work at Coyne, on actual Talking Picture and Sound Reproduction equipment.

Coyne is 32 Years Old

You get Free Employment Help as long as you live. And if you need part-time work while at school to help pay expenses we'll gladly do all we can to get it for you if you will tell us your problems. Coyne is 32 years old! Coyne training is tested—proven beyond all doubt. You can find out everything ABSOLUTELY FREE. JUST MAIL COUPON FOR MY BIG FREE BOOK, telling all about jobs—salaries—opportunities. Mail the coupon—NOW!

H. C. Lewis, Pres. **Radio Division** **Founded 1899**
Coyne Electrical School
500 S. Paulina Street Dept. 72-8H Chicago, Illinois

H. C. LEWIS, President
Radio Division, Coyne Electrical School
500 S. Paulina St., Dept. 72-8H Chicago, Ill.

Dear Mr. Lewis:—
Send me your Big Free Radio Book and all details of your Special Offer.

Name.....
Address.....
City..... State.....



HUGO GERNSBACK, Editor-in-Chief
 LOUIS MARTIN Associate Editor
 R. D. WASHBURNE Technical Editor

CONTENTS OF THE OCTOBER, 1932, ISSUE

VOLUME IV Number 4

EDITORIAL:

Radio in Europe Hugo Gernsback 201

NEW DEVELOPMENTS IN RADIO:

Describing the Latest Tubes Louis Martin 204
 The New "K" Tube C. Bradner Brown 206
 A Portable Phono-Radio Receiver-Recorder
 Dr. F. Noack 207
 The Latest Radio Equipment 208
 A Modern "3-Tube" Reflex Receiver..... H. G. Cisin 212

SERVICE MEN'S DEPARTMENT:

Operation and Service of Automatic Volume Control
 Systems W. S. Williams 211
 Constructing Adapters for Test Equipment
 F. L. Sprayberry 216
 How to Rewire the Hi-Q 29 for the New Tubes
 Hubert Lee Frazier 218
 Profits Via the Service Lab. M. C. Mancill 219
 How to Reactivate Oxide-Coated Filaments
 Raymond Shaw 220
 The Service Man's Forum 222
 Short-Cuts in Radio Service 223
 Operating Notes Bertram M. Freed 224

RADIO SERVICE DATA SHEETS:

No. 75: Galvin Motorola Model 61 Automotive Receiver,
 (with type 85 duodiode-triode tube) 226
 No. 76: Wells-Gardner Series 062 Automotive Superheterodyne 227

TECHNICAL RADIO TOPICS:

Building and Operating an Ultra-Modern Super
 Clifford E. Denton 202
 A Lapel Microphone (Part II) Dr. Irving Saxl 210
 Some Interesting Loudspeaker Facts... Eli M. Lurie 213
 The Why and Wherefore of Tuning Meters
 L. van der Mel 214
 Building Your Own A.F. Choke Coils
 C. H. W. Nason 215
 RADIO-CRAFT Kinks 228
 The Radio Craftsman's Page 229
 A Portable Short-Wave Laboratory H. Harrison 230
 RADIO-CRAFT's Information Bureau 232
 Servicing New Receivers Floyd Fausett 233
 Quasi-Optical Home Experiments... John B. Brennan 234
 Over-the-Counter Suggestions Jack Grand 256A

An Easily Built 0-800 V. Peak Voltmeter for Rectifier
 Work J. S. Williams 256B

OBITUARY: R. A. Fessenden 207

BOOK REVIEW:

N.R.I. Practical Laboratory Training Course 247

IN OUR NEXT FEW ISSUES:

ACOUSTIC FEEDBACK. In this article the author discusses the factors involved in obtaining howl-free, high-gain microphone amplifier operation.

ONE-TUBE REFLEX LOUDSPEAKER SET. High-gain potentialities existent in the new tube types become dynamic in a novel receiver design that bids fair to attract widespread attention.

CHURCH SOUND INSTALLATIONS. Technicians today must be prepared to successfully handle a sound installation in any one of the 200,000 churches in the U.S. The problems in this profitable field are discussed.

THE SPECIALTY TESTER. Service Men long have wanted this instrument, which solves the problem, "What was the resistance of that burned-out resistor?"; also, it will indicate capacity values from 250 mmf. to 14 mf.

RADIO-CRAFT is published monthly, on the fifth of the month preceding that of date; its subscription price is \$2.50 per year. (In Canada and foreign countries, \$3.00 a year to cover additional postage.) Entered at the post office at Mt. Morris, Ill., as second-class matter under the act of March 3, 1879. Trademark and copyright by permission of Gernsback Publications, Inc., 98 Park Place, N. Y. C. Text and illustrations of this magazine are copyright and must not be reproduced without permission of the copyright owners. We are also agents for WONDER STORIES and WONDER STORIES QUARTERLY. Subscription to these magazines may be taken in combination with RADIO-CRAFT at reduced Club rates. Write for information.

Copyright 1932. GERNSBACK PUBLICATIONS, INC.

H. GERNSBACK, President
 S. GERNSBACK, Treasurer

J. M. HERZBERG, Vice-President
 I. S. MANHEIMER, Secretary

Published by **TECHNI-CRAFT PUBLISHING CORPORATION**. Publication office: 404 No. Wesley Ave., Mount Morris, Illinois. Editorial and Advertising Office: 96-98 Park Place, New York City. Chicago Advertising Office: 737 North Michigan Avenue, Chicago, Ill. Western Advertising office: 220 No. Catalina St., Los Angeles, Calif. L. F. McClure, Chicago Advertising Representative. Loyd B. Chappell, Western Advertising Representative.

London Agent: Hachette & Cie., 3 La Belle Sauvage, Ludgate Hill, E.C. 4
 Paris Agent: Hachette & Cie.,
 111 Rue Reaumur
 Australian Agent: McGill's Agency
 179 Elizabeth St., Melbourne

The **ONLY** receiver
 positively **GUARANTEED**
 to give **ACTUAL**
 world-wide reception

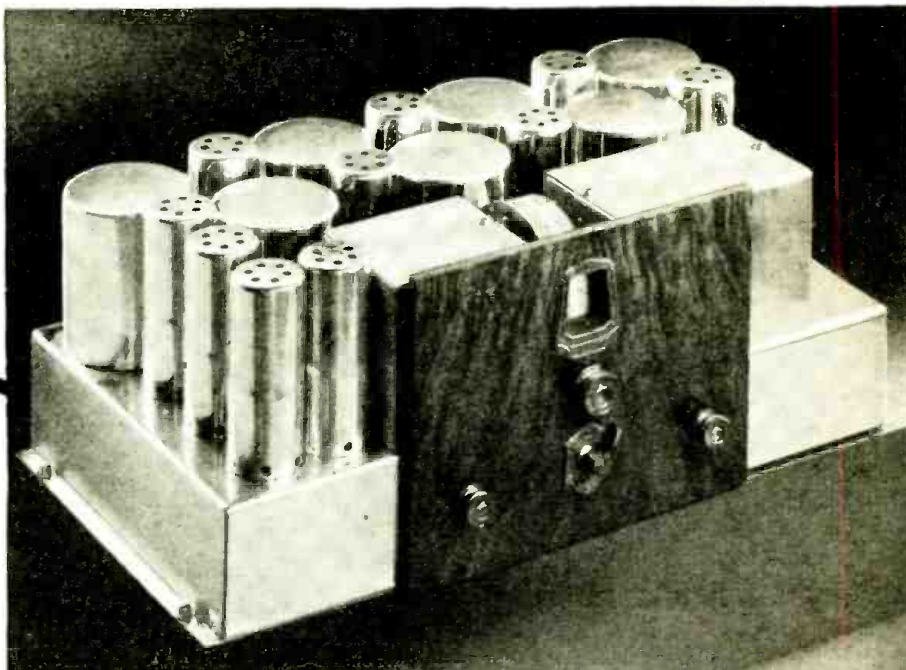
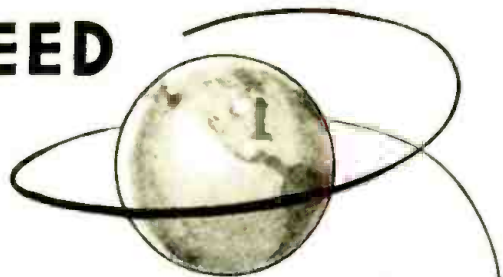

**Features of the
 Scott Allwave Deluxe**

15-550 Meters

Includes major European, Asiatic, Australian, African, South American and Domestic voice stations.

Single Dial

Tunes both R. F. and Oscillator circuits in perfect alignment automatically from 15 to 550 meters—without trimmers.

No Plug In Coils

Coils are not tapped. Entirely new system—actually MORE efficient than plug in coils.

**New Class A
 Linear Amplifier**

Gives perfectly uniform response to all frequencies from 30 to 8000 cycles at low as well as at high volume.

Twin Speakers

Give actual reproduction to the perfect, linear output of the amplifier.

Non Oscillating

100 per cent shielding enables use of maximum sensitivity without annoyance of oscillation.

There is no question—no doubt—no gamble in the purchase of a Scott Allwave Deluxe. No mere hope, to be followed by bitter disappointment. You **KNOW**—before you spend your money for a Scott Allwave Deluxe—exactly what you are going to get in performance. You **KNOW** you will hear England, France, Germany, Spain, Australia, South America and many more of the 300 intensely interesting foreign stations regularly received by owners of Scott Allwave Deluxe receivers. You know these things, before you buy because this receiver is positively guaranteed to give you actual world-wide reception . . . every day . . . regardless of which state you live in!

possible an absolute guarantee of actual world-wide reception. Only the Scott Allwave Deluxe has a sensitivity of 4-1000ths microvolt per meter at 1400 K. C.! That's one reason. The second is that the Scott Allwave Deluxe is the **ONLY** receiver having such a low natural noise level that the 4-1000ths microvolt per meter sensitivity can be used to yield loud, clear reception over distances up to 10,000 miles!

Send for PROOF!

A great independent laboratory has charted the sensitivity, selectivity and tone of the Scott Allwave Deluxe. These charts **PROVE**, beyond any question of doubt that the Scott Allwave Deluxe will **POSITIVELY** give you the foreign reception you want . . . the 90 channel broadcast selectivity you want, and the tone you want. Send today for this convincing **PROOF** . . . then, you will understand fully why the Scott Allwave Deluxe is the only receiver that **CAN** be sold with a definite, unconditional guarantee of actual, world wide reception. Clip the coupon. Mail it at once.

**Why This Amazing Guarantee
 Is Possible**

It might seem strange that no one else can offer the purchaser such absolute certainty of satisfaction on the subject of foreign reception. Yet it is not strange when all the facts are understood, because . . . only the Scott Allwave Deluxe has the electrical characteristics that make

The
SCOTT
ALLWAVE
DE LUXE
 15-550 meter
 Superheterodyne

THE E. H. SCOTT RADIO LABORATORIES, INC.
 4450 Ravenswood Avenue · Dept. RC10 · Chicago, Illinois

E. H. SCOTT RADIO LABORATORIES, INC.
 4450 Ravenswood Ave., Dept. RC10 Chicago, Ill.

Send me fully detailed technical description of the new Scott Allwave Deluxe.

NAME.....
 STREET.....
 TOWN.....STATE.....

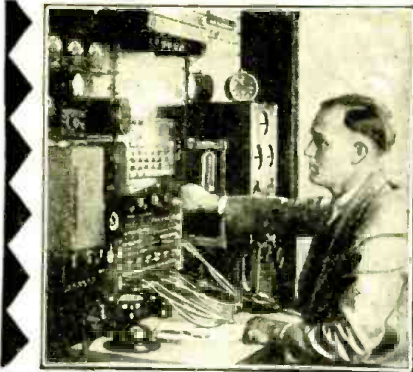

Broadcasting Stations employ trained men continually for jobs paying up to \$5,000 a year.



Police Departments are finding Radio a great aid in their work. Many good jobs have been made in this new field.

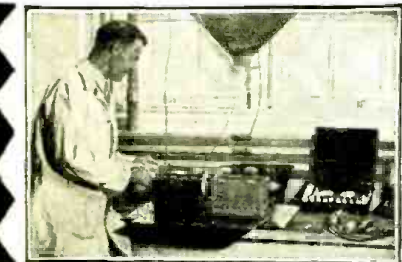

Spare time set servicing pays many N.R.I. men \$200 to \$1,000 a year. Full time men make as much as \$65, \$75, \$100 a week.

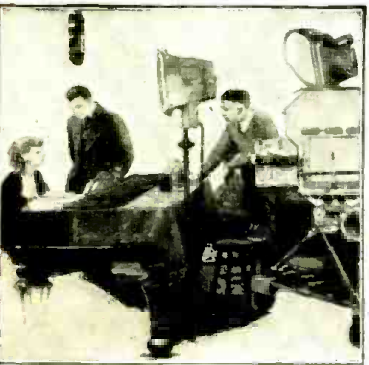

Talking Movies—an invention made possible by Radio—employs many well trained radio men for jobs paying \$75 to \$200 a week.



Television—the coming field of many great opportunities—is covered by my course.

I WILL TRAIN YOU AT HOME

Many Make \$50 to \$100 a Week in Radio -- *the Field With a Future*

My book, "Rich Rewards in Radio," gives you full information on the opportunities in Radio and explains how I can train you quickly to become a Radio Expert through my practical Home Study training. It is free. Clip and mail the coupon NOW. Radio's amazing growth has made hundreds of fine jobs which pay \$50, \$60, \$75, and \$100 a week. Many of these jobs may quickly lead to salaries as high as \$125, \$150, and \$200 a week.

Radio—the Field With a Future

Ever so often a new business is started in this country. You have seen how the men and young men who got into the automobile, motion picture, and other industries when they were started had the first chance at the big jobs—the \$5,000, \$10,000, and \$15,000 a year jobs. Radio offers the same chance that made men rich in those businesses. It has already made many men independent and will make many more wealthy in the future. You will be kicking yourself if you pass up this once-in-a-lifetime opportunity for financial independence.

Many Radio Experts Make \$50 to \$100 a Week

In the short space of a few years 300,000 Radio jobs have been created, and thousands more will be made by its future development. Men with the right training—the kind of training I will give you in the N.R.I. Course—have stepped into Radio at 2 and 3 times their former salaries. Experienced service men as well as beginners praise N.R.I. training for what it has done for them.

Many Make \$5, \$10, \$15 a Week Extra In Spare Time Almost At Once

My Course is world-famous as the one "that pays for itself." The day you enroll I send you material, which you should master quickly, for doing 28 Radio jobs common in most every neighborhood. Throughout your Course I will show you how to do other repair and service jobs on the side for extra money. I will not only show you how to do the jobs but how to get them. I'll give you the plans and ideas that have made \$200 to \$1,000 a year for N.R.I. men in their spare time. G. W. Page, 110 Raleigh Apts., Nashville, Tenn., writes: "I made \$935 in my spare time while taking your Course." My book, "Rich Rewards in Radio," gives many letters from students who earned four, five, and six times their tuition fees before they graduated.

Get Ready Now for Jobs Like These

Broadcasting stations use engineers, operators, station managers and pay up to \$5,000 a year. Radio manufacturers employ testers, inspectors, foremen, engineers, service men, buyers, and managers for jobs paying up to \$6,000 a year. Radio dealers and jobbers (there are over 35,000) employ service men, salesmen, buyers, managers and pay up to \$100 a week. Talking pictures pay as much as \$75 to \$200 a week to men with Radio training. There are hundreds of opportunities for you to have a spare time or full time Radio business of your own—to be your own boss. I'll show you how to start your own business with practically no capital—how to do it on money made in spare time while learning. My book tells you of other opportunities. Be sure to get it at once. Just clip and mail the coupon.

I HAVE STARTED MANY IN RADIO AT 2 AND 3 TIMES



**\$400.00
Each
Month**



**\$800.00
In Spare
Time**



**Chief
Engineer
Station WOS**

"I spent fifteen years as traveling salesman and was making good money but could see the opportunities in Radio. Believe me I am not sorry, for I have made more money than ever before. I have made more than \$100 each month and it really was your course that brought me to this. I can't say too much for N.R.I."—L. G. Dahlstead, Radio Sta. KYA, San Francisco, Cal.

"Money could not pay for what I got out of your course. I did not know a single thing about Radio before I enrolled, but I have made \$800 in my spare time although my work keeps me away from home from 6:00 A.M. to 7:00 P.M. Every word I ever read about your course I have found true."—Milton I. Leiby, Jr., Topton, Pennsylvania.

"I have a nice position and am getting a good salary as Chief Engineer of Radio Station WOS. Before entering Radio, my salary was barely \$1,000.00 a year. It is now \$2,400.00 a year. Before entering Radio, my work was, more or less, a drudgery—it is now a pleasure. All of this is the result of the N.R.I. training and study. Your course is by far the simplest, clearest I have yet seen. You got me my first important position."—H. H. Lane, Radio Station WOS, Jefferson City, Missouri.

TO BE A RADIO EXPERT

Act Now --- Mail Coupon Below for Free Book of Facts and Proof

You Can Learn at Home in Your Spare Time to be a Radio Expert

Hold your job. There is no need for you to leave home. I will train you quickly and inexpensively during your spare time. You don't have to be a high school or college graduate. My Course is written in a clear, interesting style that most anyone can grasp. I give you practical experience under my 50-50 method of training—one-half from lesson books and one-half from practical experiments with equipment given without extra charge. This unique and unequalled method has been called one of the greatest developments in correspondence Radio training. N.R.I. pioneered and developed it. It makes learning at home easy, fascinating, practical.

Learn the Secrets of Short Wave, Television, Talking Pictures, Set Servicing, Broadcasting

I'll give you more training than you need to get a job—I'll give you your choice, and not charge you extra either, of my Advanced Courses on these subjects—(1) Television, (2) Set Servicing and Merchandising, (3) Sound Pictures and Public Address Systems, (4) Broadcasting, Commercial and Ship Radio Stations, (5) Aircraft Radio. Advanced specialized training like this gives you a decided advantage.

Your Money Back if You are Not Satisfied

I will give you an agreement in writing, legal and binding upon this Institute, to refund every penny of your money upon completing my Course if you are not satisfied with my Lessons and Instruction Service. The resources of the National Radio Institute, Pioneer and World's Largest Home-Study Radio School stands behind this agreement.

Find Out What Radio Offers, Get My Book

One copy of my valuable 64-page book, "Rich Rewards in Radio," is free to any resident of the U. S. and Canada over 15 years old. It has started hundreds of men and young men on the road to better jobs and a bright future. It has shown hundreds of men who were in blind alley jobs, how to get into easier, more fascinating, better paying work. It tells you where the good Radio jobs are, what they pay, how you can quickly and easily fit yourself to be a Radio Expert. The Coupon will bring you a copy free. Send it at once. Your request does not obligate you in any way. ACT NOW.

J. E. SMITH, President
Dept. 2KX, National Radio Institute
Washington, D. C.

FORMER PAY



Experienced Radio Man Praises N. R. I. Course

"Before taking your course, I had worked at Radio for over seven years, doing quite a bit of servicing, but I realized that I was in need of better training. From the first lesson on I began to understand points that had me wondering. The course has taught me what I could not have learned otherwise and I would not take many times the price it has cost me, for the knowledge I have gained. In a period of nine months, I have made at least \$3,500."—C. J. Stegner, 28 So. Sandusky St., Delaware, Ohio.

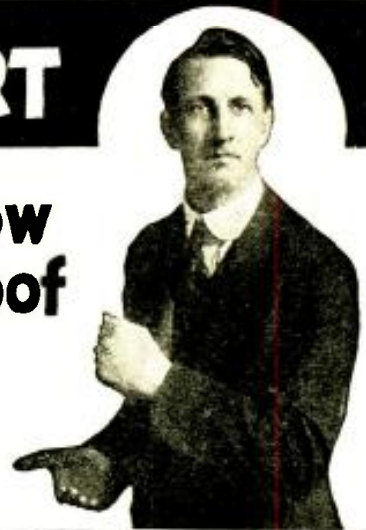

Special FREE Offer



Act now and receive in addition to my big free book "Rich Rewards in Radio," this Service Manual on D. C., A. C., and Battery Operated sets. Only my students could have this book in the past. Now readers of this magazine will receive it free. Overcoming hum, noises of all kinds, fading signals, broad tuning, howls and oscillations, poor distance reception, distorted or muffled signals, poor Audio and Radio Frequency amplification and other vital service information is contained in it. Get a free copy by mailing the coupon below. ACT NOW.

SPECIAL Radio Equipment for Broad Practical Experience Given Without Extra Charge



My Course is not all theory. I'll show you how to use my special Radio equipment for conducting experiments and building circuits which illustrate important principles used in such well-known sets as Westinghouse, General Electric, Philco, R. C. A., Victor, Majestic, and others. You work out with your own hands many of the things you read in our lesson books. This 50-50 method of training makes learning at home easy, interesting, fascinating, intensely practical.

Clip and mail NOW for FREE INFORMATION

J. E. SMITH, President
National Radio Institute, Dept. 2KX
Washington, D. C.

Dear Mr. Smith: I want to take advantage of your Special Offer. Send me your Service Manual "Trouble Shooting in D.C., A.C. and Battery Sets" and your book "Rich Rewards in Radio," which explains Radio's Opportunities for bigger pay and your method of training men at home in spare time. I understand this request does not obligate me.

Name
Address
City..... State.....

"M"

96 PAGES

OF NEW DATA HAVE BEEN ADDED TO THE

OFFICIAL REFRIGERATION SERVICE MANUAL

To bring this useful service manual right up-to-date, Mr. L. K. Wright, the Editor of the OFFICIAL REFRIGERATION SERVICE MANUAL, has added a wealth of entirely new material on electric refrigerators. This new section, which totals 96 pages, has contained therein dozens of new models of recent manufacture which have been placed on the market during the past few months and in addition, information regarding improvements on older models. As usual every refrigerator has been accurately described from the viewpoint of servicing—diagrams to illustrate the essential parts, and simplified so that repairs can easily be made.

NO EXTRA COST FOR THIS MATERIAL

The addition of these new pages will not increase the cost of the book to those who order their copy now. With the inclusion of more pages, the OFFICIAL REFRIGERATION SERVICE MANUAL will have over 1,200 diagrams and over 450 pages. Its flexible, loose-leaf binder accommodates the extra pages very easily. When the material has been placed in the manual, you will have a complete 1931-1932 OFFICIAL REFRIGERATION SERVICE MANUAL.

Radio Service Men—Turn Idle Hours Into Profit by Servicing Electric Refrigerators with the aid of this New and Complete Service Manual.

THE idea of electricians, radio service men and other mechanically inclined men, servicing refrigeration units is self-evident and the thought has occurred to perhaps untold thousands ever since electric refrigeration started. Yet nothing was done, because the average man knows little or nothing about refrigeration. Compared with servicing a radio set or wiring a home for electricity, the servicing of a refrigerator is absurdly simple, once you get the hang of it.

The OFFICIAL REFRIGERATION SERVICE MANUAL has been edited by L. K. Wright, who is an expert and a leading refrigeration authority. He is a member of the American Society of Mechanical Engineers, American Society of Refrigeration Engineers, The National Association of Practical Engineers, etc.

In this Refrigeration Manual every page is profusely illustrated; every refrigerator part is carefully explained; diagrams are furnished of every known machine; special care is given to the servicing end. The tools needed are illustrated and explained; there are trouble shooting charts, and other service data.

Remember there is big money in the refrigeration servicing business. There are thousands of firms selling refrigerators every day and they need to be cared for often. Eventually there will be more re-

frigerators than radios. Why not increase your earnings with a full or spare time business by servicing refrigerators.

Here are some of the important chapters:

- Introduction to the Refrigeration Servicing Business
- History of Refrigeration
- Fundamentals of Refrigeration
- Description of All Known Types of Refrigeration.
- Service Tools and Shop Equipment
- Motors
- Trouble Shooting
- Unit Parts, Valves and Automatic Equipment
- Makes and Specifications of Units
- Manufacturers of Cabinets
- Refrigerants and Automatic Equipment
- and Many other Important Chapters.

Several thousands of copies of the OFFICIAL REFRIGERATION SERVICE MANUAL have been sold; and there still remains the greatest opportunity for thousands more to learn how to make more money in a short time through openings in this new field.

NOW • •

OVER 1,200 DIAGRAMS

450 Pages

Flexible Looseleaf Binder

Complete Service Data

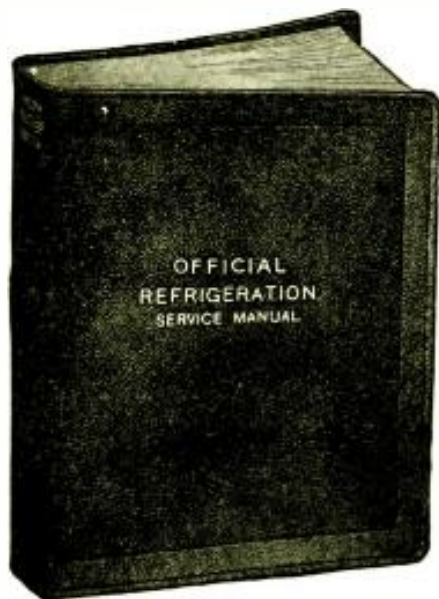

THE FIRST COMPLETE REFRIGERATION SERVICE MANUAL EVER PUBLISHED

Clip and Mail Coupon TODAY!

GERNSBACK PUBLICATIONS, Inc. RC-10-32
 96-98 Park Place, New York, N. Y.

I enclose herewith my remittance for \$5.00 (check, stamps or Money Order accepted) for which you are to send me, postage prepaid, one copy of the OFFICIAL REFRIGERATION SERVICE MANUAL, together with the extra 96 pages of new material at no extra cost.

Name

Address

City..... State.....

The Season's Big Radio Sensation!

16-TUBE ALL-WAVE ^{only} 39.95

All the New 1933 FEATURES

Completely Assembled with Large DUAL SPEAKERS

WHAT a radio! One complete 16-tube chassis with one dual-ratio dial—new Super-Heterodyne circuit with a range of 15 to 550 meters . . . STAT-OMIT Tuning Silencer . . . New Class "B" Push-Push Power Amplifier . . . Color-Lite Tuning . . . Full band automatic Volume Control . . . Duplex Duo-Diode Detection . . . Dual-Ratio Single Dial . . . No Trimmers, No Plug-in Coils, No Tuning meter or Neon light required . . . Fractional Micro-volt Sensitivity . . . Dual Powered (2 separate power Transformers) . . . Absolute Tone Fidelity . . . 18 Tuned Circuits . . . New Mercury Rectifier . . . Full-Floating Variable Condenser . . . Low Operating Cost . . . and many other sensational new features. The new Midwest 16-tube set actually uses less current than previous sets of 8 and 10 tubes. A bigger, better, more powerful, more selective, finer toned radio than you've ever seen before

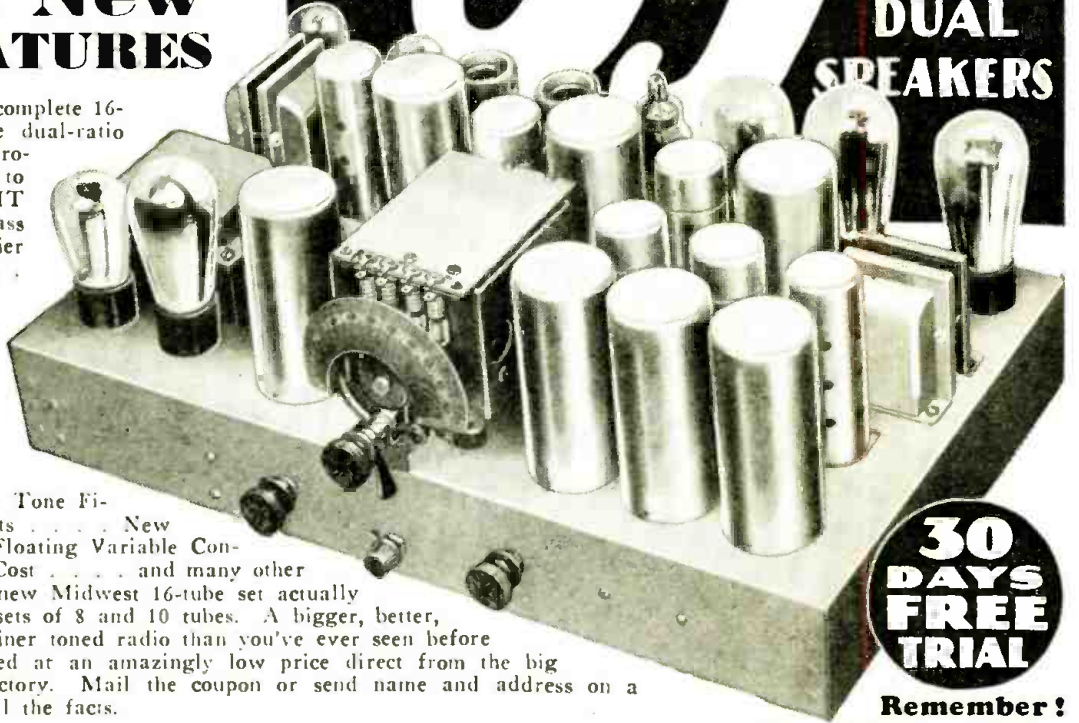

30 DAYS FREE TRIAL

... offered at an amazingly low price direct from the big Midwest factory. Mail the coupon or send name and address on a postal for all the facts.



Complete Line of New Consoles
The big new Midwest catalog shows gorgeous line of artistic consoles in the new six-leg designs. Mail the coupon now. Get all the facts. Learn how you can save 30% to 50% on a big powerful radio by ordering direct from the factory.

Deal Direct With Factory!

Don't be satisfied with less than a Midwest 16-tube A. C. radio. A receiver covering only the regular broadcast waves is *only half a set*. Improvements in short-wave programs have made ordinary broadcast sets obsolete. The Midwest gives you regular, foreign, police and amateur broadcasts in one single dial set. No converter or any extra units required.

Remember, you buy DIRECT FROM THE MAKERS. No middlemen's profits to pay. You get an absolute guarantee of satisfaction or money back. You try any Midwest 30 DAYS before you decide to keep it. Then, if you wish, you can pay in small monthly amounts that you'll scarcely miss. Mail coupon for full details or write us a postal.

SAVE

UP TO

50%

TERMS
as low as
\$5.00 DOWN

Remember!
Every Midwest set is backed by a positive guarantee of satisfaction or your money back. 30 DAYS FREE TRIAL in your own home makes you the sole judge. Midwest, now in its twelfth successful year, offers bigger, better, more powerful, more sensitive radios at lower prices than ever before. The coupon or a postal brings you big new catalog and complete information. Mail it NOW!

Read These Letters From Midwest Owners

Just two of the *thousands* of letters praising Midwest Radios.

Gets France, Spain, Italy, Japan
"I have received foreign short-wave stations such as FVA, France; EAQ, Madrid, Spain; 12 HQ, Rome, Italy; and last but not least, JJA, Tokyo, Japan. I really think the Midwest set is a miracle."
A. F. GRIDLEY,
Sarasota, Fla.

W8XK—W3XAL—W1XAZ—W2XAF
I am very much satisfied in every way with my Midwest radio. I heard Sydney, Sunday 3:00 A. M. also W8XK; W3XAL; W1XAZ; W2XAF in the evening. On the regular band have some 55 stations so far.
Aug. Balbi, 1427 Myra Ave.,
Los Angeles, Calif.

Investigate! Mail Coupon NOW!

Get the Midwest catalog. Learn the facts about Midwest 9, 12 and 16-tube ALL-WAVE sets. Learn about our sensationally low factory prices, easy payment plan and positive guarantee of satisfaction or money back. Don't buy any radio until you get the big new Midwest catalog. Just sign and mail the coupon, or write us a postal.

BATTERY RADIOS

Using the New AIR CELL BATTERY

Two sensational values: a 6-tube super-set for standard wave reception and a 9-tube ALL-WAVE, both using the new AIR CELL "A" battery that never needs recharging. Low factory prices. Coupon brings details. Mail it NOW!

MIDWEST RADIO CORP.

DEPT. 111

(Est. 1920)

CINCINNATI, OHIO

RUSH THIS COUPON FOR AMAZING FREE TRIAL OFFER AND BIG BEAUTIFUL CATALOG

Midwest Radio Corp.
Dept. 111
Cincinnati, Ohio.

Without obligation on my part send me your new 1933 catalog and complete details of your liberal 30-day free trial offer. This is NOT an order.

USER AGENTS
Easy EXTRA MONEY!
Check here for details.

Name _____
Address _____
Town _____ State _____



Tune the NEW way for World-Wide Reception with the LINCOLN DE·LUXE·SW 33

SILENT TUNING...

The weakest carrier wave is registered on the signal indicator and can be tuned with precision and perfect silence without disturbing atmospheric noises.

SIGNAL INDICATOR

A meter directly above the dial indicates, not only the weakest signal, but allows the operator to tune into a signal perfectly. Guess work is entirely eliminated. Comparative signal strength is indicated.

UNDISTORTED HIGH AMPLIFICATION.

Three stages of push pull with new system of twin-grid detection allows tremendous undistorted amplification of the high gain I. F. amplifier. The handling power of this system seems to be unlimited and tremendous volume on weak signals can be had if desired.

AUTOMATIC VOLUME CONTROL

There are two paramount advantages in good automatic volume level. First, in tuning from weak to strong signals; and secondly, in holding a steady volume level on fading stations which is so common in short wave reception. The effect of this new Lincoln feature is so efficient that a near-by stroke of lightning registers only a muffled sound in the speaker; it has the same effect on all sharp electrical interference.

NEW FIDELITY

Twin-grid detection preceded by push pull input I. F. transformers and followed by two stages of transformer coupled push pull stages, produces an undistorted register of a wide band of frequencies, giving a perfectly balanced output with realism hard to associate with radio.

All of the new reactions in the SW-33 model are what we all have wanted for years,—they are here for you today—thanks to Lincoln's foresight in radio possibilities.

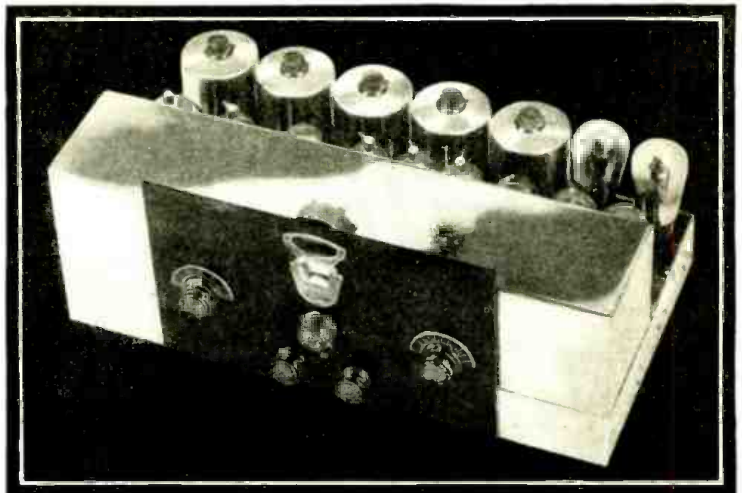

THE NEW DEVELOPMENTS

have made the new DeLuxe SW-33 just about as ideal a receiver as one could hope to own. The use of five variable mu tubes controlled by the new twin grid second detector and followed by two transformer coupled push pull stages has opened the gates to new ideas of enjoyable distant reception.

The signal indicator locates carrier waves which are difficult to hear; many times the carrier is not being used or modulated as is the case in transatlantic phone. The signal indicator registers these silent carriers and enables you to be accurately tuned, ready for the voice to be heard.

WHEN THIS CARRIER IS TUNED, ATMOSPHERIC NOISES ARE REDUCED TO A MINIMUM, AUTOMATICALLY.

Distant stations can be tuned silently, and volume then brought up to desired strength (volume control does not affect sensitivity). Perfect volume level on short wave stations is another great asset in the new Lincoln. If you have ever tuned in a foreign short wave station, or even many of our short wave stations in the U.S.A., you will appreciate the great value of uniform volume level.

The performance of Lincoln equipment has been known the world over for years. Its use by Polar Expeditions, broadcasting stations, both domestic and abroad, U. S. Naval Station operators, and hundreds of super critical DX fans, has proved Lincoln's exceptional merit.

Complete equipment consists of chassis, power equipment, auditorium type speaker and complete set of laboratory tested tubes. Chassis is finished in highly polished nickel over copper and presents a handsome appearance. Precision laboratory construction is employed throughout, and every receiver is tested on distance before shipment.

Write for description of new developments and new sales plan which overcome the present defects in the present custom built radio merchandising.

LINCOLN

DeLuxe Receivers

LINCOLN RADIO CORPORATION

Dept. RC-10, 329 S. Wood St., Chicago, Ill.

Please send information on A.C. D.C. receivers.

Name

Address

City State

Print name and address plainly



"Takes the Resistance Out of Radio"

Editorial Offices: 96-98 Park Place, New York, N. Y.

HUGO GERNSBACK, Editor

Vol. IV, No. 4, October, 1932.

RADIO IN EUROPE

An Editorial by HUGO GERNSBACK

FOR the purpose of making an intensive study of radio and television conditions as they now prevail in the foremost European countries, I recently visited Germany, France, England and Belgium.

Every facility was placed at my disposition, and in the course of my travels I visited every important radio and television laboratory on the continent. I also had numerous occasions to personally operate a number of radio receivers in all the countries visited.

In my opinion, the present radio conditions abroad may be best summed up in a single word—"Deplorable." The general quality of the European programs is, as a rule, mediocre. There are good features, and in some cases excellent ones, to be sure, but they are few and far between. What music there is, as a rule, is good, but European broadcasts suffer from entirely too many talks. Surprising as it may seem, there is no such thing as a continuous program from early morning (5.45 A.M.) until after midnight (1 A.M.)—even by large stations—such as American listeners are accustomed to. Even the big stations go off the air for hours at a time. There is also not the snap and go to the average European stations that we are accustomed to in America. They take things easy, and a few minutes wait—anywhere from 3 to 10 minutes—between programs means nothing to the European broadcaster.

But when it comes to radio reception in Europe, the conditions—to the American—are not only deplorable but chaotic. It is practically impossible to listen to a radio program in the large cities, such as in Berlin, Paris, or London. The amount of man-made interference is simply terrific, and at present no steps seem to have been taken to remedy this sad situation. Time and again I have tried to listen to programs in these various cities, but found it absolutely impossible to do so, particularly at night; but even in the daytime, listening often became impossible. In the country districts, conditions are somewhat better so far as man-made static is concerned, but all to no avail, because of the present European radio chaos.

In the United States we have the Federal Radio Commission, which polices the various wavelengths so efficiently that broadcasters must remain on their allotted frequency. In Europe, there is no central authority to enforce this prime radio rule, that is, that radio stations must stay on their assigned wavelength. Berne (Switzerland) is supposed to regulate the stations, but in practice, broadcasters do much as they please.

The result is that there is a terrific amount of interference between the stations where wavelengths overlap. This naturally gives rise to heterodyne whistles, and only rarely is a program free from such annoyances. Of course, we have heterodyne whistles on some of our stations in the United States, too, but generally these stations are in what is termed the "graveyard" wavelength, below 250 meters. In Europe, there are heterodyne whistles on the best frequencies, and it is seldom that you can select a wavelength that is free from this annoyance. This, of course, accounts for the fact that the average receiver in Europe consists of but three tubes. When you talk to Europeans of an eight, ten or twelve tube receiver, they cannot conceive of such a thing. Indeed, if you had such a receiver in Europe it would be useless. The amount of interference that the

higher sensitivity would bring in would make listening quite impossible. I listened to a few six and eight tube superheterodynes in some radio laboratories, and it was absolutely impossible to keep the set on for more than a few minutes as the din and racket was so nerve racking that it became positively hopeless to listen to it.

Indeed, as a general thing I found that Europeans who had been in the United States and who had owned or used radio sets here, do not own radios in Europe now. The explanation usually was that after being accustomed to American radio reception, they found themselves unable to listen to European programs with their eternal talks, their accompanying noises, and preferred to be without radios rather than listen to the assorted din.

I have never been a friend of our American radio practice whereby programs are sponsored by advertisers, and where advertising blurbs clutter the air all too frequently. Of course, in Europe there is little advertising on the air; practically all broadcasting stations being owned by the various governments. However, after listening night after night, for three weeks, to the European radio pandemonium, I am certain that American radio listeners, if they had been treated to a like experience, would forget their present antagonistic attitude toward our radio programs and come to the conclusion—as I have—that after all is said and done, American radio, today, is so far above that of Europe, that a comparison becomes silly.

As I have mentioned before, the average European radio set is composed of three tubes. In fully 80 percent of the sets, regeneration by the tickler method is still being used. This means that the sets produce the same sort of howls and cat music that we had to contend with up to about 1928. Of course, since that time, we have not had sets that whistle and howl, but in Europe, such sets are still the usual thing. The condition is aggravated also by the fact that all European sets must tune up to the higher wavelengths of over 2,000 meters, as some of the best stations are broadcasting on these frequencies. This makes elaborate switching arrangements necessary, which switches have not been worked out very happily in Europe so far.

Speaking broadly, it may be said that a great majority of the sets are of the regenerative and tuned radio-frequency type. Only very recently have superheterodynes been introduced, but so far, only a very small percentage of the receivers sold are what might be termed modern sets, such as we know in the United States.

As to the general appearance of the sets, they are of the 1928 vintage, according to American standards, and they are practically all of the table-model type. While it is possible that someone is building consoles in Europe—I saw hundreds of sets and operated dozens of them—I never glimpsed at a single console during my whole stay in Europe. All the sets I saw, with but one exception, had separate loudspeakers, such as were in vogue in the United States in 1926-28. In Europe, the radio set is still just a radio set, and no one seems to know what radio furniture is, such as we know the term here.

Summing up, it may be said that radio in Europe today is just about five years behind us, and it has been so ever since it started abroad. It is also quite likely to remain so, due to present economic conditions, and the slower adaptability of Europeans to new ideas.

BUILDING AND OPERATING AN ULTRA- MODERN SUPER.

By CLIFFORD E. DENTON

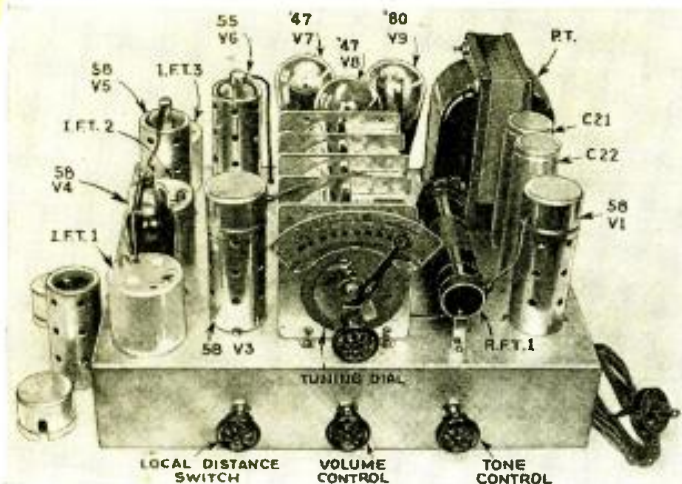

Fig. A
Front view of the completed receiver. The designations refer to the schematic circuit below.

WHILE there are many good receivers available today, at the suggestion of RADIO-CRAFT, the author constructed a 9-tube receiver of the superheterodyne type, utilizing all the new tubes that would be practically beneficial; a band-pass antenna system, to provide sufficient selectivity for those located in metropolitan areas; automatic volume control; and a diode detector. The sensitivity of this receiver is in the neighborhood of 1 micro-volt-per-meter, which should more than satisfy the most ardent DX fan, and at the same time enable distant stations to be received with ease.

If the instructions given in this article are followed, then the entire set may be built for about twenty dollars, assuming nothing in the "junk box" but a few tools.

The Circuit

A study of the circuit diagram of Fig. 1 reveals that a total of 9 tubes are used, including the rectifier. Starting at the antenna, a band-pass tuning unit feeds the signal into the receiver proper. The output of the first R.F. tube is loaded by a choke, L4, which resonates at a frequency just below the broadcast band. Coupling to the first detector, or modulator tube, is made via a small, mica fixed condenser, C24. With this resonant-

Oscillator tracking is accomplished by means of a series of padding condensers, C3A and C4 in the diagram. However, best results will not be secured unless care has been taken in the construction of the coils.

An interesting feature of this receiver is the fact that the oscillator is coupled to the first detector both conductively and inductively; conductively by means of the common resistor in the cathode leads of the oscillator and first-detector; and inductively through the physical location of the two sets of windings, that is, the oscillator and first-detector secondaries. Both of these coils are wound on the same tube and separated by about 1/2 inch.

Extremely high gain is obtained in the I.F. stages by virtue of the fact that both the primary and secondary of each I.F. transformer is tuned; and since there are three such transformers, there are six tuned circuits in the I.F. stages alone. In view of the fact that the receiver is equipped with A.V.C., the sensitivity of the various tuned stages varies with signal strength. This is so in the first R.F. and first I.F. stages; the second I.F. stage is not in the A.V.C. connection and consequently works at high sensitivity at all times. A local-distance switch is used, in series with a resistor, R14, to decrease the gain of the second I.F. stage.

choke arrangement, maximum output is secured from the R.F. stage, V1, over practically the entire broadcast band.

The new Duplex-Diode Triode is used as the second detector. (See description of this tube in the Sept. issue of RADIO-CRAFT.—Editor.) This tube, the 55, is fed from the I.F. secondary, and has both plates connected together in a half-wave connection; a center tapped I.F. transformer must be used for full-wave detection, and since such transformers are not as yet available, the half-wave connection of this tube was used. This is also desirable since a greater voltage is available for A.V.C. action, also secured from this same tube. Hence, this tube is a combination diode detector, A.V.C. tube, and since it is equipped with an additional grid and plate, it also acts as an audio amplifier. An especially interesting feature is the fact that the diode portion of the tube is resistance-coupled into the triode portion, and the latter transformer-coupled into the push-pull output stage.

A tone control, consisting of C20 and R13 is shunted across the secondary of the push-pull transformer to facilitate the accentuation of the lower register, if so desired.

The Automatic Volume Control

Automatic volume control is obtained in a novel manner. Tube V6, the Duplex-Diode Triode, supplies the voltage. Note that the cathodes of both the first R.F. and first I.F. tubes return, through grid bias resistors R2 and R8, directly to the cathode of V6. Therefore, the bias voltage appearing across R11 supplies the triode portion of V6. The voltage across R10 supplies the potential for the tubes oper-

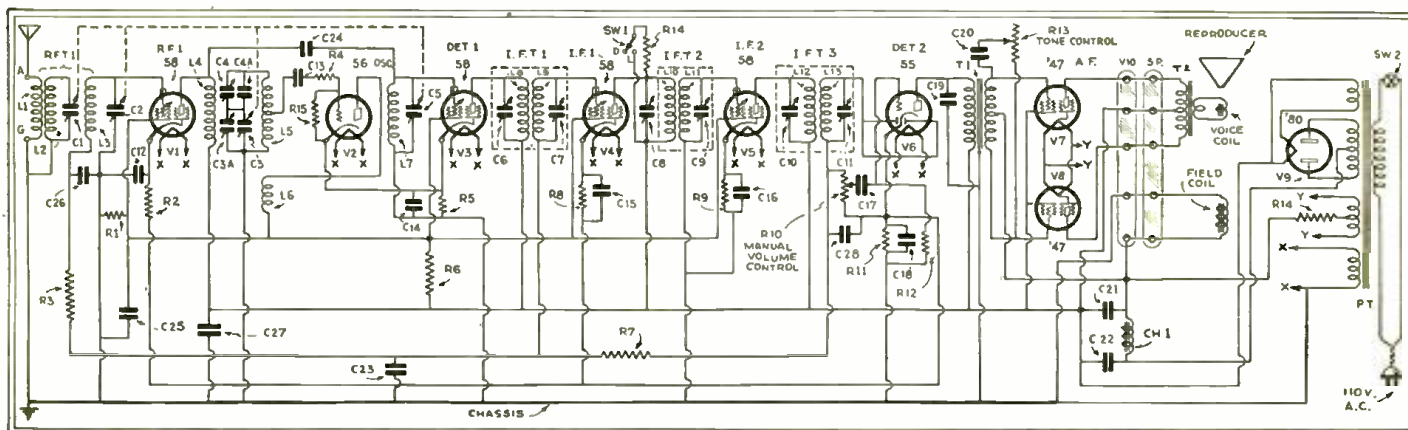

Fig. 1
Complete schematic circuit of the receiver. Note the use of the new 55 in the second-detector circuit.

RADIO-CRAFT always attempts to bring before its readers the latest devices and the latest application of these devices. To accomplish this, we have prevailed upon Mr. Denton to construct the receiver described here. This receiver uses, as may be seen, type 58 tubes in the R.F. and I.F. stages; the new type 55 Duplex-Diode Triode as combination second detector, first A.F., and A.V.C. tube; and two pentodes in a push-pull connection.

A single evening's test convinced us of the tremendous sensitivity and selectivity of the set. Between the hours of 9 and 10 P.M., over 50 stations were logged, and without any interference of any sort. Local stations were tuned out in a half a degree on the dial, and a distant station tuned in on the next channel!

We believe that this is the most up-to-date receiver ever described that may be constructed at home.

ating under the influence of A.V.C. Manual control of volume is obtained by varying the arm of the potentiometer R10.

The time of delay of the A.V.C. action is about .1-second, the exact amount depending upon the accuracy of the time-delay circuit composed of R7 and C23. Additional isolation in the form of R3 and C26 decouples the first R.F. stage from the remainder of the set.

Coil Data

Full constructional details of the coils are given in Fig. 2. Note that the antenna coil in Fig. 2A is wound in honeycomb fashion at one end of the tubing and is held in place by means of collodion and small pieces of adhesive tape. The three coils on this form are all wound in the same direction.

The first-detector and oscillator coils are wound on a second form as shown in Fig. 2B, a half-inch separating the two coils. Care must be taken to place the plate winding of the oscillator on that end of the grid coil nearest the end of the tubing, as shown. The list of parts at the end of this article gives the name of the manufacturer of the coils, in the event the constructor desires to purchase them.

Winding data for the I.F. transformers are given in Fig. 3. Each of the windings (both primary and secondary) consist of 800 turns of No. 36 D.S.C. wire on a wooden core one-half inch in diameter. Further spacing details may be secured from Fig. 3.

Construction

The set is simple to construct although there are nine tubes employed; simply use care in mounting and soldering all electrical connections. Chassis specifications

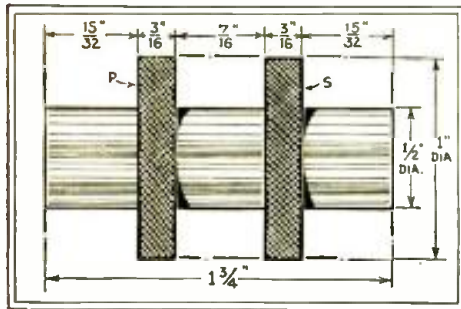

Fig. 3

Winding details of the I.F. transformers.

tions are given in Fig. 4, but must be changed if material other than that specified is used. A cadmium-plated chassis may be purchased fully drilled and folded in accordance with the above specifications. Made of steel and with welded joints, it presents an attractive appearance.

Mount the sockets, band-pass coil, electrolytic condensers, four-gang tuning condenser, and the power transformer on top of the chassis as shown in the photographs in Figs. A and B. Place all tube shield-bases on their respective sockets, and after this is done, mount the intermediate-frequency transformers. Be sure that the third I.F.T. has its control-grid lead running down through the chassis to the plates of the 55 tube. All other material is mounted under the chassis. The fixed condensers and the resistors are supported solely by their leads; the two 1. mf. bypass condensers and the push-pull transformer are bolted down.

(Continued on page 237)

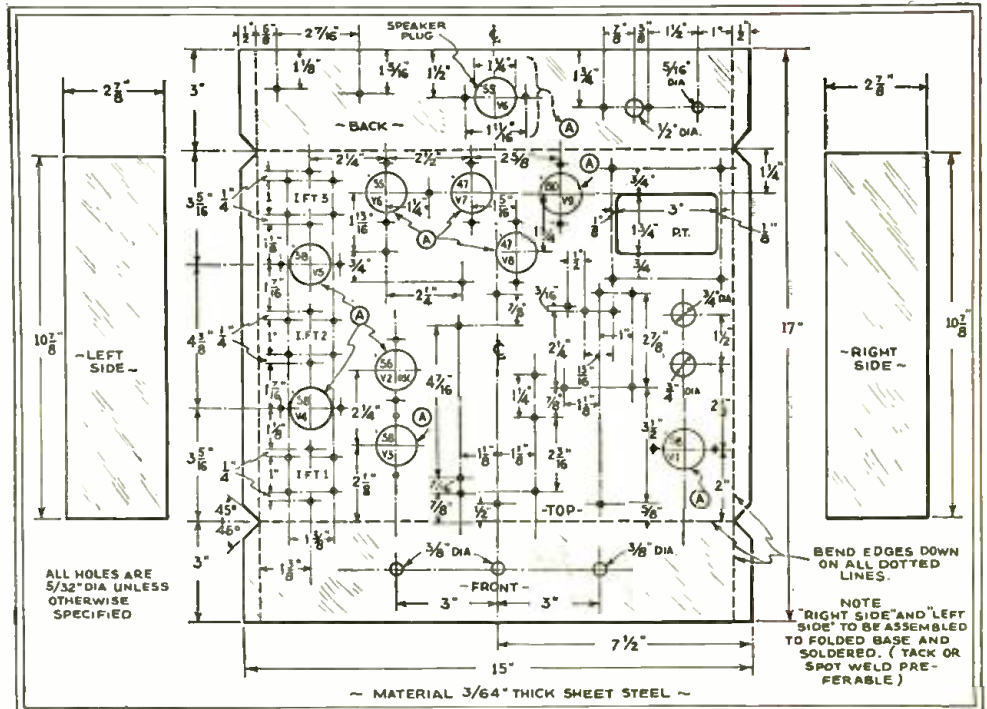

Fig. 4

Complete chassis layout. The location of the parts is indicated by their respective cut-outs.

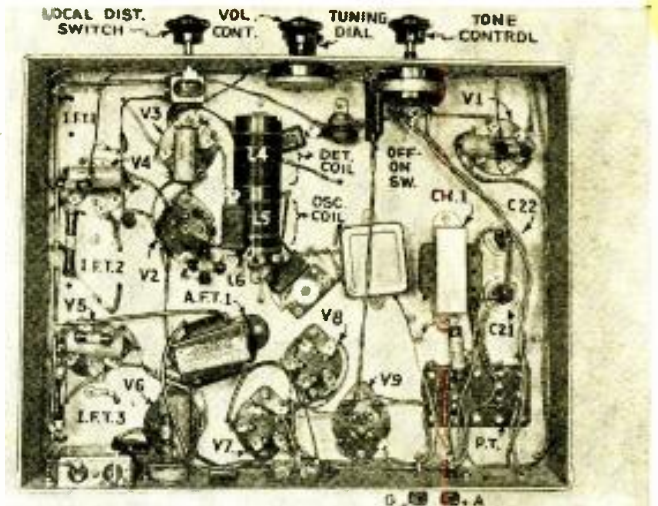

Fig. B

Under-chassis view of the receiver. The simplicity is evident.

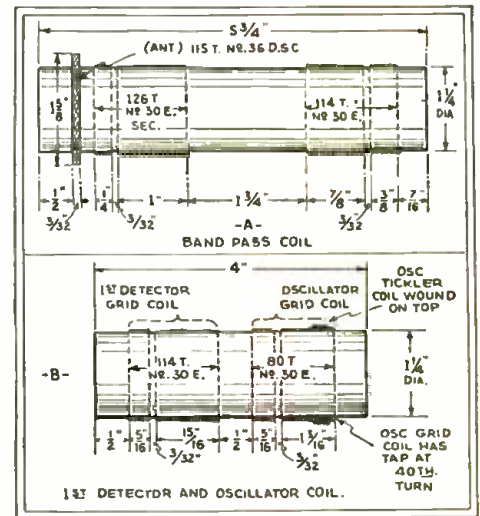

Fig. 2

Constructional details of the R.F. coils. The band-pass unit is shown at A, and the detector-oscillator unit at B.

DESCRIBING

THE LATEST TUBES

A new universal automotive output tube and a special combination amplifier and power rectifier complete this month's description of the latest tubes used in radio work.

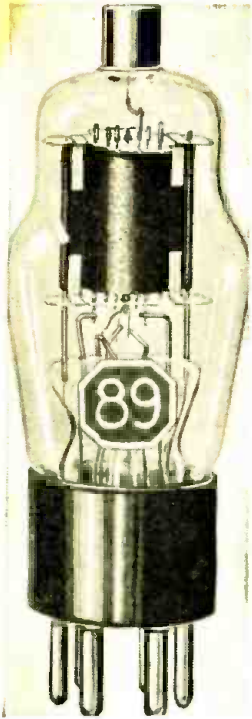

Fig. A

By LOUIS MARTIN

THIS month there are two tubes that we will describe. The first of these is of the automotive type; the second, a special tube incorporating a power rectifier and radio amplifier in a single envelope. The latter tube, while it is not commercially available at this time, indicates quite clearly what the trend is.

The 89

The 89 is a triple-grid power amplifier tube of the heater-cathode type recommended especially for use in automobile receivers or for other types of mobile service. The triple-grid construction of this tube, with external connections for each grid, makes possible its application as (1) a class A power-amplifier triode, (2) a class A poweroutput pentode, and (3) a class B power output triode.

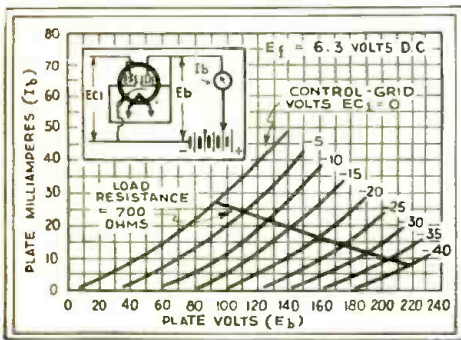

Fig. 1
Plate-voltage—plate-current curves of the 89.

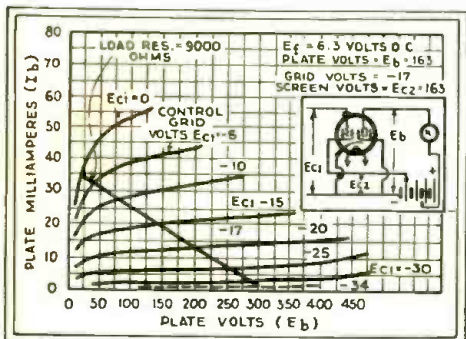

Fig. 2
Curves illustrating pentode, class A operation.

The three-fold application of the 89, shown in Fig. A, to audio power-amplifier circuits is made possible by different connections of the three grids incorporated in the tube's structure. Thus, one arrangement of grid electrodes provides a triode for class A service with a low amplification factor, a low plate resistance, and a high mutual conductance; while another provides a triode with an amplification factor so high that negative grid bias is not required for its operation as a class B amplifier. A pair of 89's so connected in a class B output stage is capable of supplying a large amount of power with relatively low plate voltage and with unusual overall economy of power consumption. A third arrangement of the grids makes possible the use of the 89 as a class A power output pentode capable of giving large power output with relatively small signal voltage input.

In class A service, the grid of the tube is maintained negative with respect to the cathode by an amount such that some plate current flows at all times, and such that the grid takes no appreciable current during the most positive swing of the signal voltage. These operating conditions are obtained when the normal bias without signal gives sufficient operating plate current to permit the application of a peak signal equal to twice the bias value without reducing the plate current below a certain predetermined minimum value under the load conditions employed, or without swinging the grid positive. Thus, the value of grid signal voltage which can be applied to any given type of tube is

limited and this results in limited power output. *Theoretically*, the maximum plate circuit efficiency for class A operation is 50 percent, assuming a sine wave input signal. The *actual* plate circuit efficiencies, however, are of the order of 20 percent for triodes and 40 percent for pentodes.

Characteristics of the 89

Figure 1 shows a family of plate voltage—plate-current curves of this tube when operated as a triode, that is, when the suppressor and screen-grids are connected directly to the plate. The applied signal is then fed between the control grid and the cathode in the conventional manner. In Fig. 2 is shown class A operation when this tube is used as a pentode, that is, with the suppressor or third grid connected directly to the cathode and the screen-grid to some positive voltage higher than the cathode.

In class B service, the tube is operated so that the plate current is practically zero with no grid excitation. When a signal of sufficient magnitude is applied to the grid, there will be no plate current flow over a substantial part of the negative half-cycle. In other words, plate current flows only during the least negative excursions of the signal voltage. A considerable amount of second and even higher order harmonic distortion is thus introduced into the power output of a single tube. However, with two tubes in a balanced push-pull circuit, the even harmonics are eliminated from the power

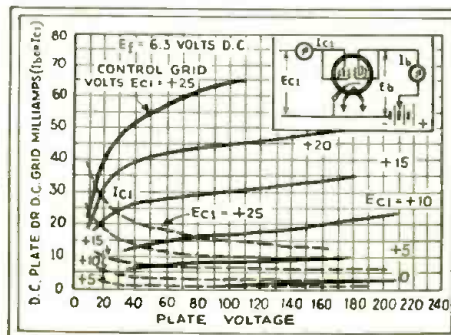

Fig. 3
Curves of the 89 as a class B amplifier.

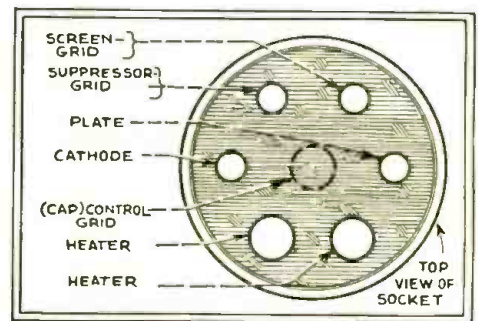

Fig. 5
Socket connections of the new 89.

output. In such a circuit, therefore, two tubes may be employed as class B amplifiers to supply virtually undistorted output.

In class B service it is possible to drive the grids of the two amplifier tubes positive to a certain amount and still obtain reasonably undistorted output, provided that sufficient input power is available to supply the grid current required by the positive grids. This power is conveniently supplied by a class A power amplifier feeding the grids of the output tubes through a push-pull transformer having proper characteristics. Usually this transformer has a step-down ratio.

By designing class B amplifier tubes with a sufficiently high mu-factor, it is possible to operate them with zero grid bias, and so dispense with biasing resistors whose effect would be to produce considerable loss in sensitivity because of degenerative effects. Since provision for grid bias is unnecessary with such tubes, the entire voltage of the rectifier is available for plate supply.

Distinguishing features of this class of service are that very high output of good quality may be obtained with fairly small tubes operating at relatively low plate voltage; and that unusual overall economy of power consumption is possible because the plate current is very low when no signal is applied to the grid. To give these advantages, the class B amplifier circuit requires the use of two tubes in a balanced output stage preceded by a driver stage capable of supplying considerable undistorted power and the use of a power supply capable of maintaining good voltage regulation regardless of the variation of average plate current with signal intensity. It should be noted that the distortion present in the high power output of class B amplifiers is usually negligible, but is always somewhat higher for the ordinary range of signals than that obtained with class A amplifiers employing much larger tubes capable of operating at the same maximum power output.

Figure 3 shows a family of plate-voltage—plate-current curves of the tube when operated as a class B amplifier. In the same curve, in dotted lines, the grid-

current characteristics are also shown. Class B connection may be secured by connecting the suppressor grid directly to the plate and the screen directly to the control grid. The input signal is then applied in a conventional manner as in all triode tubes. An inspection of the curve will show that high grid-current flows when the plate voltage is low.

Figure 4 is an interesting set of curves inasmuch as they indicate how the power output and plate current varies when two type 89 tubes are connected for class B operation, which in turn are driven by a single 89 in a class A connection. At A, the transformer ratio between the class A driver and class B stage is 2.4; the output load impedance from plate to plate being 9,400 ohms. In B of the figure, the input transformer ratio is 3.7 and the output impedance from plate to plate is 13,600 ohms. It will be seen that in the first instance, the total harmonic distortion is about 8 percent and at B, the harmonic distortion is about 5 percent for maximum signal input.

The base of the 89 is of the small 6-pin type as shown in Fig. 5. Its pins fit the standard six-contact socket which may be installed to operate the tube either in a vertical or in a horizontal position. For horizontal operation, the socket should be positioned with one filament pin opening vertically above the other.

The D.C. resistance in the grid circuit of the 89 operating as a class A amplifier (either with triode or pentode connection) should not exceed 1.0 megohm if self-bias is used. Without self-bias, the resistance should not exceed 0.5 megohm. The use of resistances higher than these may cause the tube to lose bias due to the grid current with the result that the plate current will rise to a value sufficiently high to damage the tube.

The direct-current requirements of class B circuits are subject to fluctuation under operating conditions. The power supply, therefore, should have as good regulation as possible to maintain proper operating voltages regardless of the current drain. For this purpose, a high voltage "B" battery or a suitably designed "B" eliminator may be employed. If the latter is used, a rectifier tube of the mer-

(Continued on page 235)

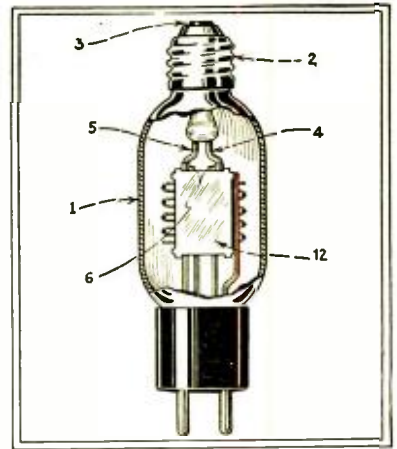

Fig. 6
External view of the amplifier-rectifier.

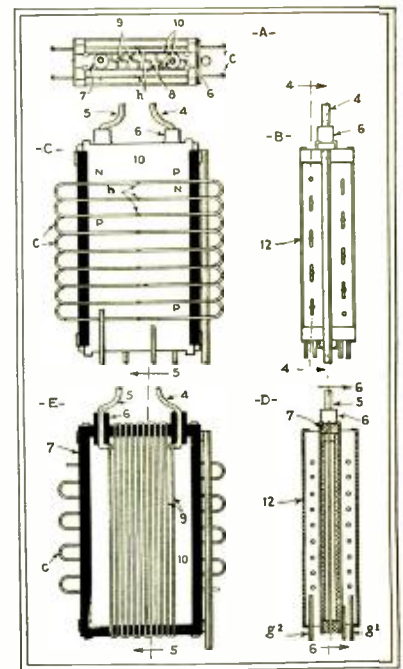

Fig. 7
Details of the internal construction of the tube.

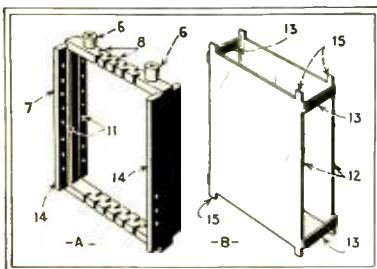

Fig. 8, above.
Details of the grid support and plates.

Fig. 9, right.
Schematic circuit showing how the tubes may be used in a power rectifier circuit. With the proper connection of the grids, which are self biasing, the tube may be connected to a source of A.C. and operated directly without a separate rectifier tube.

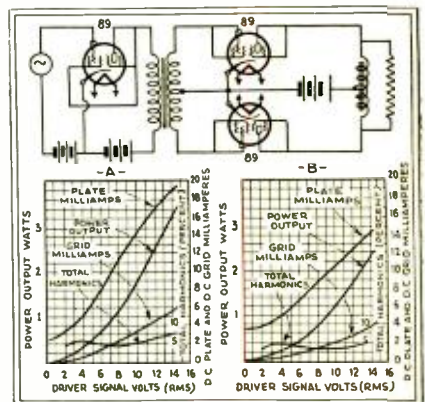
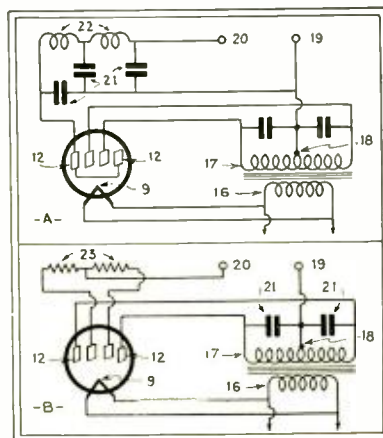

Fig. 4
Variation of power output and plate current.

THE NEW "K" TUBE

The efficient use of relays demands a vacuum-tube that has been designed specifically for such purposes. The author describes such a tube in the article below.

By C. BRADNER BROWN



Fig. A
The "K" tube, designed especially for relay work.

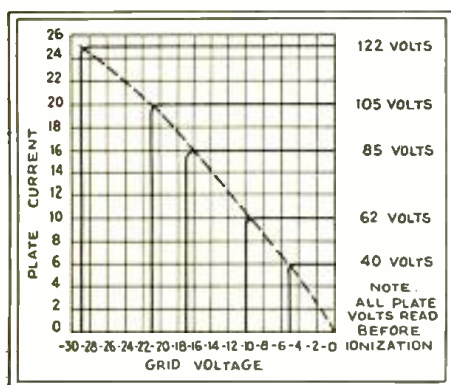

Fig. 1
A family of grid-voltage—plate-current curves.

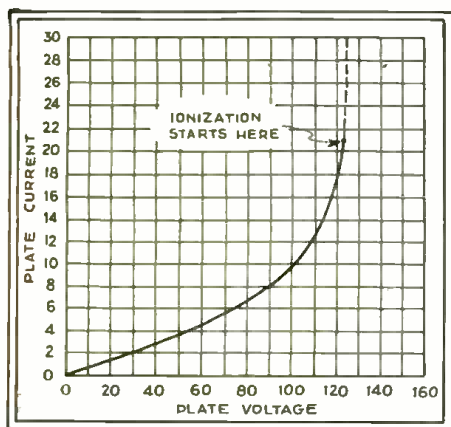

Fig. 2
Ionization starts with a plate voltage of 120.

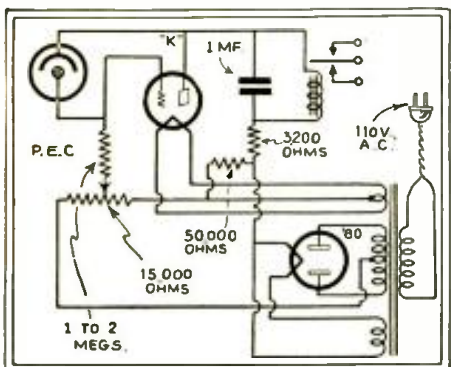

Fig. 3
Schematic circuit showing the use of the "K" tube.

THE new "K" tube was developed in response to the need for a vacuum tube which would have more favorable characteristics for relay operation. The author having done considerable experimenting with photo-cell amplifier and associated relay equipment has come to the conclusion that the present high-vacuum tubes are not eminently suitable for relay operation. The main reason for this is found in the inherent action of a high-vacuum tube. When the grid voltage is changed, the plate current is changed, the amount depending on the change in grid voltage. This change in plate current, however, follows a smooth curve and therefore a point will be found at which the relay is pulled in with not quite enough force to operate the armature. This point is called the "threshold" of operation and when held at this current, the relay will chatter, resulting in the burning or pitting of the contacts. Even when operated at the point of grid voltage cut-off, this condition will be found unless a considerable grid shift is used to operate the tube.

The thyatron tube offers a much better characteristic for relay operation as the action of the grid is to turn the plate current on—more in the manner of a snap switch. The type "K" tube is an adaptation of the thyatron tube using neon gas instead of the customary mercury vapor. The conducting gas is the secret of its peculiar characteristics which will be discussed later. It was constructed using the elements of the old type CG1162, because this tube has a circular construction using a cylindrical plate which considerably simplifies the calculation of electrostatic field strengths and surface densities. The operation of the gas filled three-element tube is as follows:

The electrons emitted from the filament are accelerated toward the plate by the positive plate voltage. These electrons collide with molecules of neon, knocking loose electrons from the outer rings of the atomic structure. These released electrons are also attracted to the plate and, in turn, break up other molecules of the gas increasing the electron flow until the gas is thoroughly ionized. When it is in this condition, there are plenty of free electrons in the tube, and the resistance

is very low which will result in the flow of large plate currents. It is necessary to use a filament which will withstand the bombardment of the positive ions which are necessarily released to be attracted to the filament. The coiled tungsten filament used in the type "K" tube is admirably suited for this duty as it is very rugged and not affected noticeably by the positive ions.

If the grid is made sufficiently negative, the plate current will be reduced to zero as all electrons emitted by the filament will be returned to the filament by the negative grid. The tube will be inactive in this condition, but current will begin to flow again as soon as the grid voltage is reduced to the cut-off point. When the current starts to flow, the tube will ionize and its resistance reduce to almost zero. Once started however, the grid is powerless to stop the flow of current as the electrons are being released by the gas itself and not by the filament. The ionization can only be stopped by reducing the plate voltage to a value sufficient to stop ionization. If alternating or pulsating voltage is used on the plate, this condition is fulfilled at every cycle or alternation. The output of a full-wave rectifier particularly adapts itself to the operation of the type "K" tube and was used in the experimental relay hookups which were set up to test the operation of the tube.

The remarkable characteristics of the type "K" tube are shown in the form of a family of plate-voltage—plate-current curves in Fig. 1. The sharp cut-off action when the tube is operated with a negative grid bias is extremely valuable when the operation of a relay is to be considered. The corners are naturally rounded off slightly when used with rectified A.C., but this action is not noticeable in actual tests. It can be seen that a sudden increase of plate current from zero to some positive value takes place when the negative grid bias is reduced past a certain critical point. It is this "breakover" action which prevents the chattering of relay contacts and allows the use of much more insensitive equipment than normally is the case. Fig. 2 shows the ionization characteristics in the form of a plate-voltage—plate-current curve for zero grid bias. The current increase to above 200
(Continued on page 245)

A PORTABLE POWER-RADIO PLAYER-RECORDER

By DR. F. NOACK*

● The idea outlined in this description of a novel German development, introduced at Leipzig Spring Fair, may be applied in many ways.

erman Radio Exposition by the German several sets for the pleasure of phonograph. Only one exception, these designed that only an amateur radio enthusiast could manipulate them—since they consisted mainly of the components requisite to making such records, and were not designed for convenient operation by the layman.

This exception was the equipment introduced under the name Schackto-graph; it is illustrated in Fig. A in finished form and is the instrument shown at the succeeding Leipzig Spring Fair.

The Schackto-graph incorporates a radio receiver chassis which includes a 3-stage A.F. amplifier capable of delivering an output of 2.5 watts; the output of this section of the instrument feeds into a magnetic reproducer which also is part of the assembly; then, there is the turntable and its associated motor; finally, there is a microphone and a recording-reproducing head. (To meet the demands of German power systems the Schackto-

graph is designed to operate at 110, 127 or 220 volts, A.C.)

By means of a switching system it is possible to arrange the circuit for a number of services, to wit: (1) Disc recording of radio programs; (2) disc reproduction of radio programs; (3) disc recording of impromptu programs; (4) disc reproduction of impromptu programs; (5) radio program reproduction.

In this particular machine the cutting needle may be steel, diamond or sapphire. The magnetic reproducer may be conveniently disconnected from the circuit, and the output run into a dynamic reproducer, if desired; the field excitation current being supplied at terminals on the receiver. The magnetic unit built into the chassis is used not only to reproduce the radio programs picked up by the set, but also as a means of monitoring the audio output of the A.F. amplifier portion of the assembly, before or during the recording of impromptu programs (such as singing or talking by the operator or his friends, etc.).

A device of this nature achieves a versatility combined with utility that certainly places it in a class by itself. In

this instance of bringing "the mountain to Mohammed," the only requisite is a 110-volt power line.



Fig. A. The Schackto-graph receiver-recorder.

*Berlin Correspondent.

R. A. FESSENDEN DIES



● In the passing of Professor Reginald Aubrey Fessenden, who died July 22 at Hamilton, Bermuda, at the age of 65 years, the technical world mourns the loss of one of its most colorful pioneers.

Although of Colonial American ancestry—the family came to Cambridge, Mass., in 1628—Professor Fessenden was born in Milton, Province of Quebec, Canada.

His experimental work with radio dates from the early '90s, when he first investigated "Hertzian waves" and at that time held, against the opinion of other investigators, that these radiations, in their method of propagation, bore a direct relationship to light; and that they traveled as "continuous waves" and not as a "whiplash" action. He accomplished the radio transmission of speech by a commutator method in 1900, at Cobbs Point, Md.; in 1903 the distance had been increased to 25 miles through the use of the continuous arc. He instituted radio broadcast programs from Brant Rock, Mass., in 1906; a high-frequency alternator of his design made this practicable.

Professor Fessenden's inventions include the loop antenna, silicon iron for transformers, high frequency alternator, the heterodyne principle, automatic relay radio, induction telephony by means of a copper diaphragm and exciting coil, Empire cloth, submarine telephone, echo-type depth finder, iceberg and submarine locators, the tracer bullet, ultra-audio sound signalling, and three hundred others.

In the magazine series, "Men Who Made Radio," appeared a short biography and cover illustration, in colors, of Professor Fessenden.

A man of strong will, he fought to maintain his convictions and often against almost overwhelming odds. He created a furore in the commercial world when, in 1925, he propounded the following oft-quoted Law of Invention:

"No organization engaged in any specific field of work ever invents any important development in that field, or adopts any important development in that field until forced to do so by outside competition."

A man of high ethics, Professor Fessenden contributed greatly to placing modern invention on a plane by itself as a field worthy of the best efforts of an individual; in this connection he is quoted as follows: "Invention is an art; just as much so as painting, or doing fine machine work."

In Memorium, we again, humbly, quote Professor Fessenden: "We shall be remembered for a hundred things, our literature, our surgery, our medicine, our chemistry, our wars. But most of all we shall be remembered for our inventions."

* RADIO-CRAFT, January 1930, page 309.

THE LATEST RADIO EQUIPMENT

NEW NA-ALD SOCKETS

THREE sockets, all of the 6-prong type are now available for consumer use from the Alden Manufacturing Co. The type illustrated at the extreme left is for base-board mounting; that in the upper center



New Na-Ald sockets.

for subpanel mounting; and that at the extreme right has a special flange suitable for subpanel mounting with two screws—that shown in the center having but a single hole. They are known respectively as types 486, 426, and 436.

LYNCH ANTENNA KIT

THE September issue of this magazine contained an article on short-wave collectors. This article stressed certain types of construction for the antenna in order to efficiently receive short waves. Another recommendation was the use of an antenna coupler connected as shown in the article—Fig. 2 at C—and pictorially illustrated below. Reduction of noise pickup is accomplished by transposing the lead-in by means of transposition blocks constructed as shown in the article and pictured below. All of the above apparatus are now available from the Lynch Manufacturing Co.

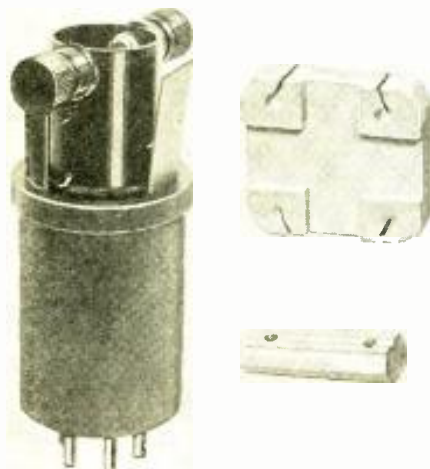

Lynch antenna kit.

RADIO CITY ADAPTERS

NEW tubes mean new adapters, if test equipment is to be kept up to date. Shown below, at the extreme left, is an example of a 5-hole to 5-prong adapter suitable for use in tube testers, analyzers, radio sets, in fact anywhere where tubes are used. Manufactured by the Radio City Products Co., they have been especially designed to accommodate the Service Man who must have the proper adapter at a low cost. They are made in all types and sizes for all the new tubes including the new 7-prong tubes which will be announced shortly.

R.F. CHOKE FOR THE 82

THE recently announced 82, mercury-vapor rectifier, functions because of the ionization of the mercury in the tube. As the voltage applied to the tube increases, the mercury starts to ionize, slowly at first and then more rapidly until the maximum current flows. This rapid increase in current generates high-frequency currents which must be prevented from entering the radio set if efficient operation

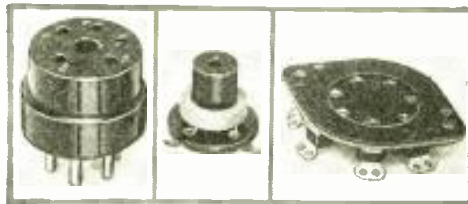

Left, adapter; center, R.F. choke; right, 7-prong socket.

is to be secured. Manufacturers of the 82 recommend a small R.F. choke to be inserted in series with the "B" minus lead between the power transformer and the filter unit. Such a choke, manufactured by the Sun Radio Co., shown above at the center, is rated at 2 milli-henries and is capable of carrying a current at 250 ma., the rated value of the 82 rectifier.

NEW 7-PRONG SOCKET

ALTHOUGH the new 7-prong tubes have not been announced at this writing, they are "just around the corner," but manufacturers have already produced the socket in anticipation of future business, as may be seen by reference to the photograph above (at the extreme right). The socket illustrated has many desirable features: the terminals are well spaced; riveted to a single piece of Bakelite, and a lasting, firm contact is insured by the fact that additional springs keep the contact surface tight against the tube pins at all times.

OAK S.-W. SWITCH

OAK MANUFACTURING CO., by effecting an all-wave switch that is noiseless in operation, has solved the problem of "switching noise" for short-wave receivers and converters. This new switch

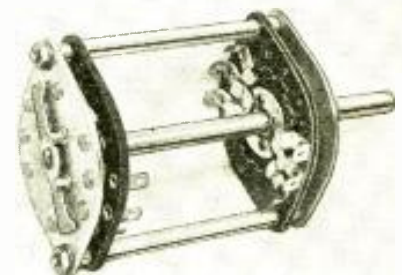

New Oak all-wave switch.

is said to have a lower contact resistance than any other radio switch now available—actually less than .001-ohm. The contact is of the double surface-cutting type as may be seen by reference to the photograph above, and is silver plated to minimize deterioration. Other important advantages are a well-defined stop action. Bakelite dielectric, and rust-proof cadmium-plated frame.

NEW BEEDE METERS

THE Beede Instrument Co. announces a new line of meters for the Service Man, one of which is illustrated below. They are low priced and some of the features include a D'Arsonval moving coil movement; large, laminated permanent magnets; new method of gap spacing which minimizes the collection of dust; and sapphire bearings. They are made in various sizes and sensitivities to accommodate every purpose.

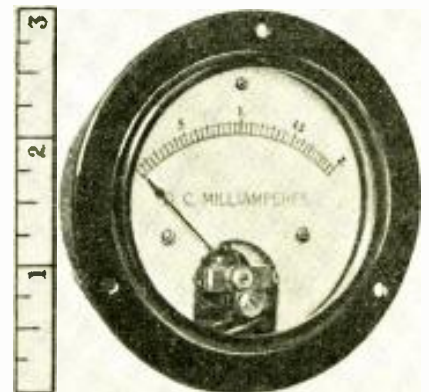

New Beede meter.

CROSLY ROAMIO

MANY new and distinctive mechanical features have been incorporated in the new Crosley Roamio automobile receiver depicted below. This small receiver



The Crosley Roamio.

is contained in a gray-silver metal case of a size small enough for easy installation either on the floor in front, between the driver and passenger; below the dash; in the rear, either fitted snugly against the driver's seat or between the passengers in front of the rear seat.

A new type antenna, slung under the chassis of the car by two clamps, eliminates the removal of the upholstery in order to secure a satisfactory antenna. The tubes used are as follows: A '36 as a combination oscillator and detector; a '37 as A.V.C. and second-detector; a '39 as first I.F. amplifier; a '36 as second I.F. amplifier; a '37 as first A.F. amplifier; and a 41 output stage.

"OHM-SPUN" RESISTORS

"OHM-SPUN," is the name given to a woven, new type resistor unit, manufactured by the States Co. It is a light, non-inductive resistor. Instead of winding the resistance wire on an insulating form, it is spun in a plane, as shown below, so the current in adjacent wires flows in opposite directions, thus reducing the inductance to practically zero.

They are available in two types; the type A for frame and the type B for flat-surface mounting. They are 6-inches square and available in sizes up to 1,000 ohms, $\frac{1}{4}$ ampere each, in the type A mounting.

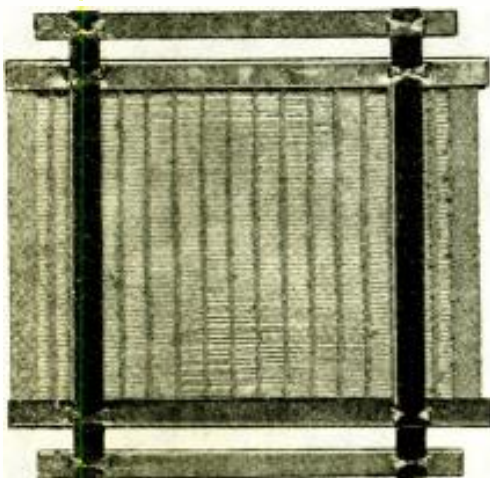

The Ohm-Spun resistor.

MAGNETIC SPEAKER

MAGNETIC speakers seem to be coming into their own again, to judge from the number of receivers, especially of the automotive type, that are making their appearance. As an aid toward portability, the new unique magnetic speaker, shown here, fills a long-felt want, for it is only $6\frac{1}{4}$ inches in outside diameter and but 3 inches deep. An unusual type of rotary drive between the armature and the cone is employed, which places the resonant frequency of the driving mechanism outside of the audible range. The pole pieces are of laminated iron and the rotary drive shaft is insulated electrically and acoustically at both ends by

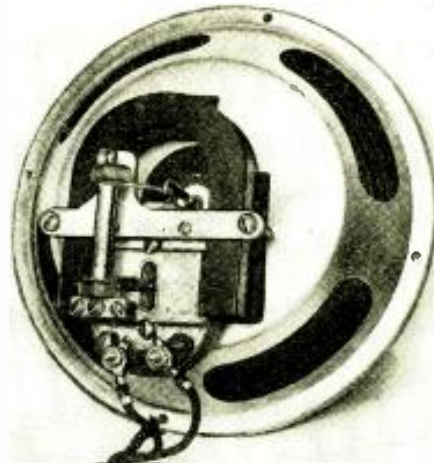

A small magnetic speaker.

rubber washers, to insure uniform reproduction.

This speaker, a product of the Best Manufacturing Co., is specially desirable in portable receivers, or in any location where space is at a premium.

A UNIQUE VOLUME CONTROL

BECAUSE the ear is more sensitive at the middle than at either end of the audio register, it is desirable to vary the volume of a radio receiver in such a manner that the low and high notes are not distorted. This feature is accomplished in the new device manufactured by the Allen-Bradley Co., shown below.

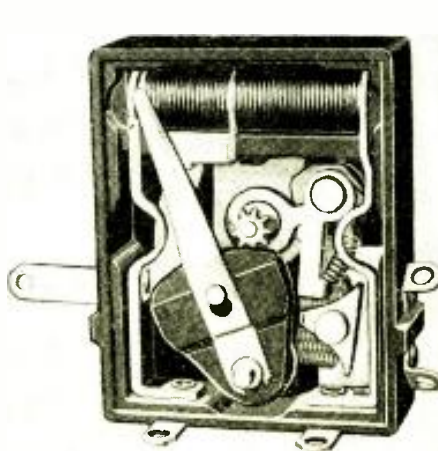

Here's a real volume control.

VOLT-OHMMETER

THE Franklin Radio Corporation has recently announced their new model 1 Voltmeter-Ohmmeter. Mounted in a laminated bakelite panel, and housed in



An volt-output meter.

a hardwood finished case, this instrument is designed for voltage ranges of 3, 30, and 600 volts, and ohmmeter ranges of 0-10,000 and 0-100,000 ohms. When used as a voltmeter, the instrument has a sensitivity of 1,000 ohms per volt.

All necessary pin-jacks and push buttons are mounted on the front panel; a $4\frac{1}{2}$ -volt battery for the ohmmeter is housed in the case itself. Of course, provision is made for battery-voltage compensation.

TWO-SPEED MOTOR

CHANGING from 33- $\frac{1}{3}$ to 78 R.P.M. is accomplished by a single lever in this phonograph motor produced by the General Industries Co., Inc. They are made

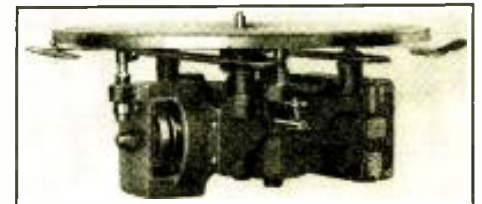

A two-speed phonograph turntable.

in two types, the model D for 10- and 12-inch records, and the model H for 16-inch records. All gears are enclosed and run in oil.

Two additional features are the facts that (1) it will not overheat in closed cases and cabinets, and (2) absolute uniformity of speed under severe variations of voltage fluctuations and record drag is maintained.

A LAPEL MICROPHONE

In this, the final of a series of articles concerning the Lapel Microphone, electrical characteristics and application are discussed, for the first time, by Dr. Saxl, authority on physics and radio.

PART II

By DR. IRVING J. SAXL*



In our last article in RADIO-CRAFT we have seen how the new lapel microphone makes possible free movement of the speaker before the audience; non-obvious pickup of his voice; and allows sound amplification to be thus introduced in places, and with individuals, where microphonic amplification would not be feasible heretofore.

We have a tiny button, almost invisible, controlling the energy of many watts in loudspeakers all over an auditorium or convention hall. How is the transformation of the sound impulses into electrical impulses from the lapel microphone achieved?

We know already that the sound waves, striking the membrane of the microphone, produce a variation in the resistance of this microphone because the carbon granules filling the space between the carbon button and the actual membrane is pressed more or less together. If a voltage is applied between membrane and carbon button, the carbon granules will be able to conduct more current than if no pressure takes place. A sound wave is nothing but a succession of variations of the pressure falling upon the lapel microphone. These variations, which are almost proportionate to the sound energy produced, are converted through this microphone as a variation of electrical impulses.

Dependency of Sound From Microphone Current

While there is, at present, no receiver existing—the action of which is perfectly linear to sound waves falling upon it—it is possible by proper engineering to select its electro-acoustical characteristics in such a way that a satisfactory sound reproduction is received. The first part of this transformation from sound into electrical energy takes place in the microphone itself, and from here, naturally, the first control of the sound is affected.

Consider, for instance, the electrical resistance of the microphone. By choosing proper carbon grains it can be varied from less than one hundred to several hundred ohms. This resistance has to

be matched to the impedances of the input transformer, as shown in Fig. 1, the best performance taking place if the impedances at the output and input sides have approximately equal values.

Another important item is the amount of current sent through the microphone. While it would seem probable, at first glance, that the amount of current would influence only the total quantity of electro-acoustical impulses transmitted through the microphone, it will be readily seen by reference to Figs. 2A and 2B that not only quantitative but definite qualitative changes of the transmitted sound take place, in accordance with the amount of current transmitted through the microphone.

Figs. 2A and 2B show the frequency response characteristics of this lapel microphone taken both at a current of 10 and 20 milliamperes passing through the microphone. It will be readily understood that the total acoustical energy produced with 20 milliamperes is differently distributed over the entire frequency range than it would be with 10 milliamperes. It is especially remarkable that the production of the highest frequencies, about 6,000 to 7,000 cycles, and the lowest frequencies, have increased several times more than the maximum energy output, which takes place at 3,000 cycles per second. This means, that by passing more

(Continued on page 238)



Fig. A

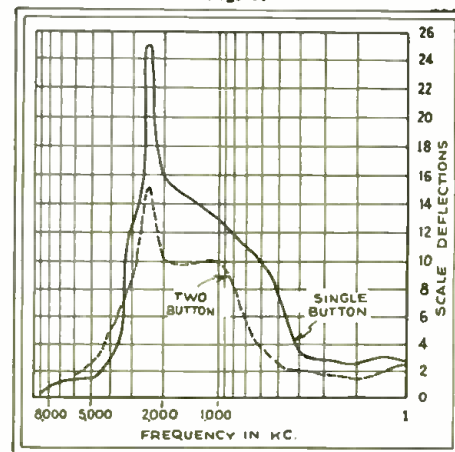

Fig. 3

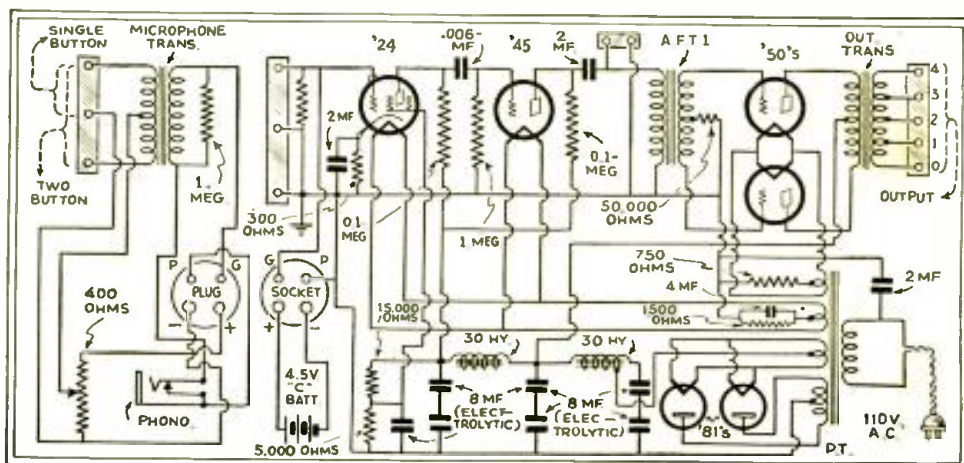
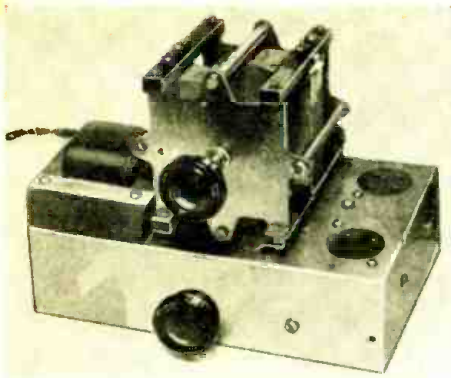

Fig. 1

*Consulting Physicist.



A very compact unit; it may be located in almost any convenient spot.

A MODERN "3-TUBE" REFLEX RECEIVER

Here's a description of a "three-tube" receiver which revives the once much-used reflex system.

By H. G. CISIN, M.E.

THE PZ pentode and other more recently announced tubes offer many fascinating possibilities to experimentally-inclined radio fans. These tubes may be used advantageously in T.R.F. circuits, superheterodynes and practically all other standard circuits. Realizing this, it was decided to try out some of the new tubes in the "reflex" circuit; several different combinations were tried, with very excellent results.

It seems as though the reflex circuit has been unjustly neglected by radio engineers. Five or six years ago, the writer had occasion to test a number of the reflex sets designed by David Grimes, and even at that time, remarkable results were obtained with the circuit. Taking advantage of the great advances and improvements in vacuum tubes, it is now possible to design a three-tube reflex, capable of outperforming a modern four-tube T.R.F. receiver and superior to the old reflex sets having six and seven tubes.

In the reflex circuit described in this article, a PZ pentode serves the dual functions of first R.F. and power A.F. amplification; the first R.F. portion of the circuit being untuned.

A tuned circuit is used to couple the two R.F. stages. A variable- μ type of pentode, the 58, is used in the second stage. This is coupled by means of a tuned impedance to the detector. The inductance is the secondary of a standard R.F. coil; the capacity is furnished by the second .00035-mf. section of the dual variable condenser.

One of the new general-purpose, type 56 tubes is used as a detector. The A.F. output of the detector is reflexed (fed back) through the type PZ pentode, which is thus made to function doubly—in the first instance, as an R.F. tube, and, finally, as the A.F. output tube.

The 2,500-ohm field coil of the dynamic reproducer serves as the filter choke; this inductance is bypassed by two 4 mf. electrolytic condensers; the capacity specified is sufficient for reducing the hum to a negligible value.

The screen-grids, cathodes, etc., of all the tubes are bypassed

by small fixed condensers wherever necessary, thus assuring smooth operation.

Volume is controlled by means of a 10,000 ohm "tapered" potentiometer connected in the cathode circuit of the type 58 tube. A fixed series resistor 11, limits the *minimum* negative grid bias.

An Amperite is employed in series with the primary winding of the power transformer. This keeps operation normal regardless of line-voltage fluctuations and also serves as a protection to the tubes and other components of the receiver.

Constructional Data on the 3-Tube Reflex

Six socket holes are drilled in the aluminum sheet before the latter is bent to the size specified for the chassis. The hole for the flush-mounted power transformer is also cut at this time.

After the chassis is formed, the wafer sockets are mounted. One of these, the speaker connection socket 26, is mounted on the rear chassis wall.

The power supply transformer, 31, is mounted next and then the dual variable condenser 7, 17 and the antenna binding post, 1. No ground post is necessary, as no external ground is used. The trimmer condensers, 7A, and 17A, are fastened in the insulated framework at the side of the dual variable condenser.

The chassis is next turned upside down and the R.F. choke 2, and the three electrolytic condensers 25, 25A and 29 are fastened on the rear chassis wall. Fixed condensers 21 and 16, R.F. choke 20 and the potentiometer-and-switch unit 12, 32 are mounted on the front chassis wall. The R.F. coils 6 and 15 are mounted on the underside of the chassis; dual condenser 8, 9 is mounted on the side wall. Finally, the various fixed condensers, flexible resistors, etc. are fastened in position. These are soldered as close as possible to the part with which they function. This reduces and simplifies the wiring.

Having completed the assembly, the set is now ready for the wiring. A break is made in one of the leads from the primary of the power transformer 31, and the switch 32 and Amperite socket 33 are connected in series in this circuit. Diagonally opposite socket terminals are used for the Amperite, (viz: one small prong terminal and one filament prong terminal).

The PZ tube uses a 5-prong socket. The control-grid connection is made at the terminal separated from the other four. Of these other terminals, the two center ones are for filament connections. Looking at the underside of the socket, the plate terminal connection is at the left, while the screen-grid is at the right.

Looking at the underside of the 6-prong type 58 tube socket, the two large terminals are for the filament leads. The next terminal to the right is for the cathode connection and to the right of this is the suppressor-grid terminal, which is connected back to the cathode *externally*: i.e., at the socket terminals. To the left of the filament terminals is the plate terminal and the remaining terminal is for the screen-grid connection. The control-grid connection is made at the cap of the tube.

The 56-tube socket is connected the same way as a '27. The

(Continued on page 239)

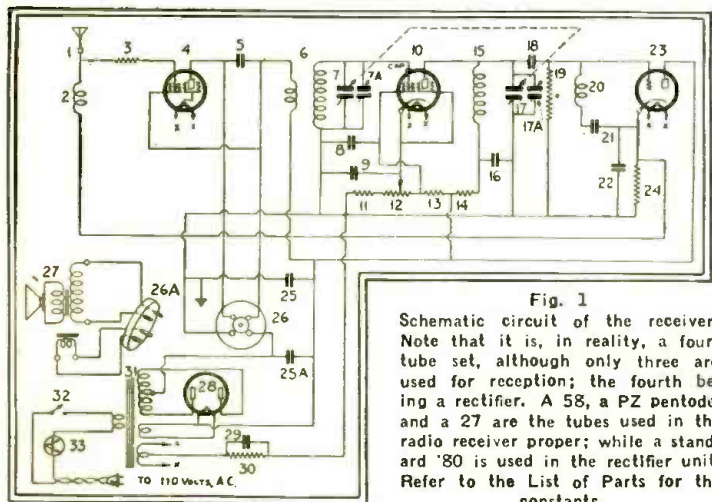

Fig. 1
Schematic circuit of the receiver. Note that it is, in reality, a four-tube set, although only three are used for reception; the fourth being a rectifier. A 58, a PZ pentode, and a 27 are the tubes used in the radio receiver proper; while a standard '80 is used in the rectifier unit. Refer to the List of Parts for the constants.

SOME INTERESTING LOUDSPEAKER FACTS

Some preliminary loudspeaker data is given in this first of a series of articles which will deal with the use of multiple speakers in radio sets.

By ELI M. LURIE

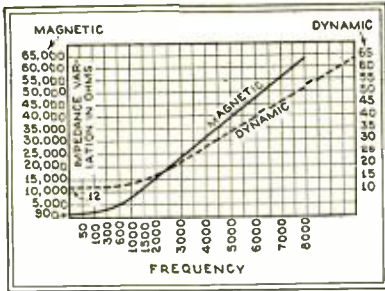

Fig. 4
Impedance variations of magnetic and dynamic speakers.

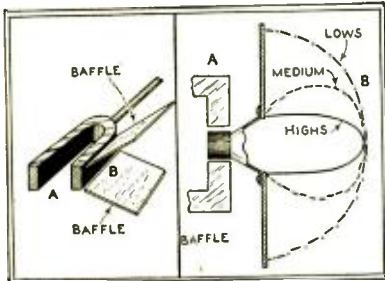

Fig. 5, left. A tuning fork baffle.
Fig. 6, right. Energy distribution from a dynamic speaker.

MANY technical articles have been written on various types of radio loudspeakers. To read and understand this avalanche of information would require considerable effort and time. In order to obviate such a tiresome procedure, this article has been prepared. Although it is by no means a complete thesis on the subject, it does contain the basic principles behind the modern loudspeaker. Some of the material has been compiled from notes, while most of the information has been taken directly from engineering journals dating as far back as 1925.

We generally associate the dynamic loudspeaker with recent progress but though the speaker of today is really new, the basic idea is not. As early as 1898 Sir Oliver Lodge, the renowned English scientist, was issued a patent on this identical thing. As a matter of fact, it was he who made the first permanent magnet dynamic type of speaker. In Fig. 1 is shown a sketch of his idea. A bar-magnet is used to supply a constant field. The voice coil is suspended as shown and when a fluctuating current passes through the coil it moves right and left. Thus, a real dynamic speaker

was engineered over thirty years ago. This same principle is used in the Telautograph writing machine, the device used in banking institutions, hotels etc. for the reproducing of one's handwriting at a remote location.

One of the greatest handicaps in the design of a loudspeaker is inherent resonance. At the present time there is no type of speaker that does not have some resonance. By this is meant the tendency of the different parts of the speaker to continue to vibrate after the signal has stopped.

In the magnetic type of loudspeaker the cone driven by a *prime mover* or vibrating reed, usually a brass or steel rod of about 3/64-inch in diameter. A permanent magnet is generally the polarizing agent. Now the prime mover or reed is a tuned mechanical system that has a definite resonant point. This resonant point can be varied by damping or limiting the vibration of the reed, but if damping is used in order to either raise or lower the resonant point above or below the audible-frequency spectrum, there will naturally be a considerable loss in intensity.

Referring to the *diaphragm* or cone of the speaker, resonance will usually take place at the fundamental frequency, and will always be accompanied by a series of overtones which will vary in regard to the fundamental; in other words, they may be two, three, five or six times the frequency. In fact, there may not only be even harmonics, but any odd number as 3.6 times the fundamental frequency. This, naturally, aggravates the resonant condition, and in a way is similar to the reed in that they are both tuned resonant systems; the difference being that the

resonant positions of one will not coincide with those of the other. If each is allowed to vibrate separately, it is possible to draw two resonant curves of the situation as in Fig. 2.

Harmonics in Speakers

In any electrical circuit where close coupling between two separate circuits exists, a resonant curve of the complete unit will have two distinct humps. This phenomenon is analogous to the combining of both the reed and cone, which is generally done by fastening the reed securely to the apex of the cone by means of a nut and thread. The resonance curve drawn for this combination will be that of a composite vibrating system and will have two humps similar to that of the two tightly coupled electrical circuits. The harmonics have not been shown; the actual effect of these would be to superimpose little ripples on the main curve.

Thus it can be readily understood why, up to the present time, we have been unable to obtain flawless and perfect reproduction. Perhaps it would be unwise to say that perfect reproduction is impossible, but it is true that, until we learn how to entirely eliminate the natural effects of resonance, perfect reproduction is very improbable. Efforts have been made to design a speaker with a continuance of resonant positions, the ultimate idea being to approach the ideal by making use of *resonant points all over the complete spectrum*, so that the aperiodicity of the speaker will depend on the resonant points and not on the vibration that is normally associated with the cone when in unresonant oscillation. The big problem with such a speaker is to cause the amplitude of vibration on the resonant positions to conform to the applied input in such a manner that a linear condition between input voltage and power output is the result. Otherwise, the amplitude of some of the resonant positions will be much greater than others, with the resulting non-linear response characteristic. The more resonant points that are used and the closer together these points are grouped, the closer the ideal condition will be approached, provided of course,

(Continued on page 241)

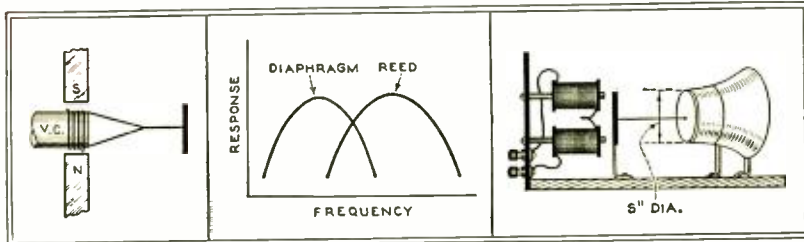

Fig. 1

Fig. 2

Fig. 3

THE WHY AND WHEREFORE OF TUNING METERS

By L. VAN DER MEL

A TUNING METER, as the name implies, is a device used to indicate when the radio receiver is tuned to the peak of the signal (tuned exactly to resonance). It is not necessary that the device itself be a voltmeter or a milliammeter; all that is required is some form of indication when the signal has been fully tuned in. Tuning meters are used in sets where the selectivity is high, and therefore some means is necessary to determine exactly when the carrier is tuned in, so good quality may be secured. (Especially useful for short-wave work.)

In receivers of the superheterodyne type, a hissing noise may be heard when tuning between stations, which disappears when tuned to resonance because of the demodulation of the noise by the stronger carrier. If, in such receivers, a tuning meter is employed to indicate exact resonance, clear reception is insured. In any event, they are used in modern receivers, and a knowledge of where they may be used and "why" is essential for good servicing.

The D.C. Meter

Most people are familiar with the action of the ordinary D.C. milliammeter used so extensively in modern radio service work. It is commonly known that they will not read A.C. Why? Refer to the diagram of Fig. 1. Here is shown an A.C. voltage applied to a D.C. meter. During the positive halves of the cycle, the pointer of the meter tends, let us say, to move up the scale to the right, and during the negative half of the cycle it tends to move off the scale to the left. If the frequency of the voltage is very low, the pointer of the meter is able to follow the variations of the impressed voltage, although no steady reading can be obtained. As the frequency of the voltage is increased, the mechanical inertia of the pointer prevents its following the rapid variations in the applied voltage so that its reading (if it reads any value at all) is the average value of the impressed voltage or current through the meter. In other words, any D.C. meter reads average values only.

The average value of the sine wave shown in Fig. 1 is obviously zero, and hence the meter reads zero. Even if the frequency is so low that the pointer is able to follow the variations faithfully, the average reading of the meter is zero. This leads us to the conclusion that just because a D.C. meter reads zero does not

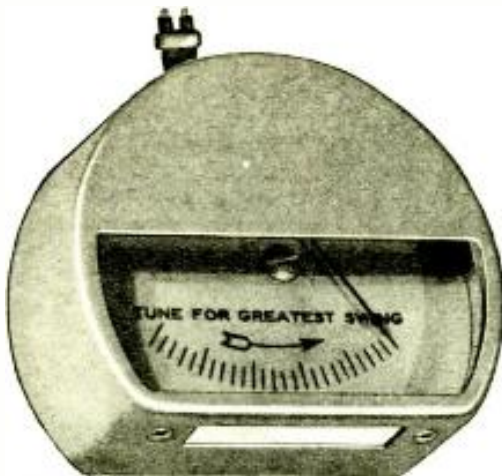

Photograph of a commercial tuning meter. Note that the scale is reversed from top to bottom.

necessarily mean that no current is flowing through it—in fact, if the peak value of the A.C. through a D.C. meter is great enough, the meter may burn out while it is reading zero!

Where to Use the Tuning Meter

If the above is true, where, then, may such a meter be connected in a radio set in order to indicate the signal strength? Suppose it is connected in the plate circuit of an amplifier as indicated in Fig. 2. If the amplifier is of the class A type, the plate current variations through the meter will increase above and decrease below the value of current flowing when no signal is received; furthermore, the amount of increase is equal to the amount of decrease, and hence the signal variations have no effect upon the normal reading of the meter with no signal received. Obviously, the plate circuit of a class A amplifier is no place for a tuning meter.

If it cannot be placed in the usual amplifier, let us see what happens in the detector circuit. If the value of resistor R in Fig. 2 be increased so the tube is now a detector (which is the same as connecting the meter in the detector circuit), the amount of increase above normal current (the increase being due to a signal) is greater than the decrease below normal (due to the negative half-cycles of the same signal). The plate current now flowing through the meter, because of the signal, is shown in Fig. 3. It is seen that the plate current reading of the D.C. meter has increased by an amount A because of the signal. Thus we may conclude that a D.C. milliammeter may be inserted in the plate circuit of the detector (power detector assumed) and the meter may be called a "Tuning Meter."

Further, it should be pointed out that if the detector circuit in which the meter is inserted is of the grid-leak and grid-condenser type, the reading of the meter will decrease with an increase in signal strength which, of course, is contrary to the action of power detector.

The Tuning Meter in A.V.C. Circuits

An examination of some of the more recent commercial receivers employing automatic volume control (A.V.C.) will indicate that the tuning meter, if any, is connected in the plate circuit of the amplifier circuits, usually the I.F. amplifier in superheterodynes—which at first

(Continued on page 240)

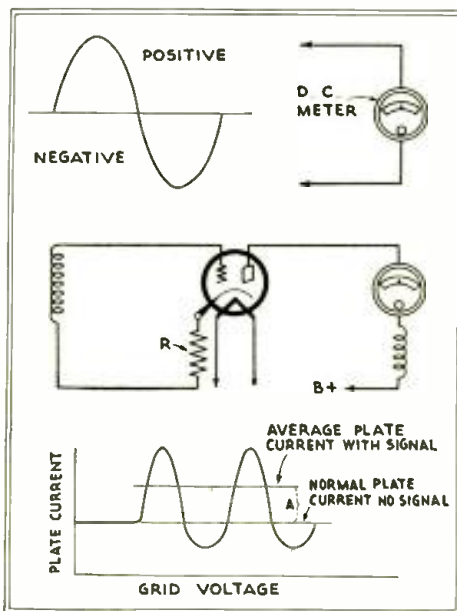
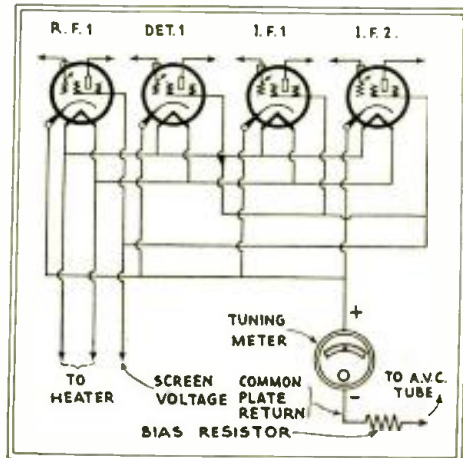

Fig. 1, above. A typical sine wave.
Fig. 2, center. Where the tuning meter may be placed.
Fig. 3, below. Why the tuning meter reads.



Circuit showing how the tuning meter may be used in a superheterodyne.

BUILDING YOUR OWN A. F. CHOKE COILS

By C. H. W. NASON

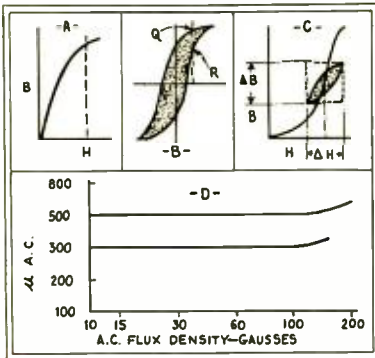

Fig. 1

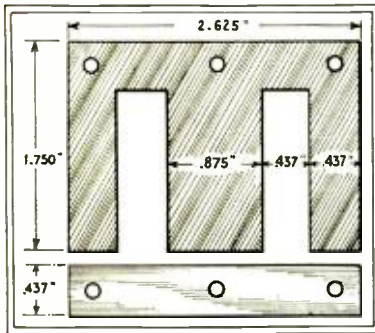

Fig. 2

FILTER chokes designed for a given inductance require calculations far outside the abilities of the average amateur. Before discussing actual simplified design methods it might be well, however, to discuss briefly the factors involved. Certain relations are involved in the design of the magnetic circuit which are briefly as follows:

Factor	Equation	Unit of Expression
H (the magnetic force)	$4 \pi N I$	Gilberts per Cm.
ϕ (the flux)	$\mu H A$	Maxwells
B (the flux density)	ϕ/A	Gausses
μ (the permeability)	B/H	Numeric value.

In these equations:

- l = the magnetic path in cms.
- A = the cross section of the core in sq. cms.
- N = the number of turns.
- I = the current in amperes.
- $\pi = 3.1416$

If we pass a gradually increasing current through the winding surrounding a

magnetic material the relation of B to H is as shown in Fig. 1A. If the current through the winding is now decreased it will not follow the original path of the curve but will take another course as shown in Fig. 1B. Thus for a given value of H a twofold value of B corresponding to Q and to R in Fig. 1B are found. (This is due to the residual magnetism in the core and the condition is known as "hysteresis." Naturally, the smaller this loop the better is the core material for magnetic purposes.)

If with a fixed D.C. magnetizing force a small A.C. voltage is superimposed, a minor hysteresis loop appears as is indicated in Fig. 1C. It is from the minor loop that we determine the permeability of the core material to alternating currents, and it is this that we employ in calculating the in-

(Continued on page 243)

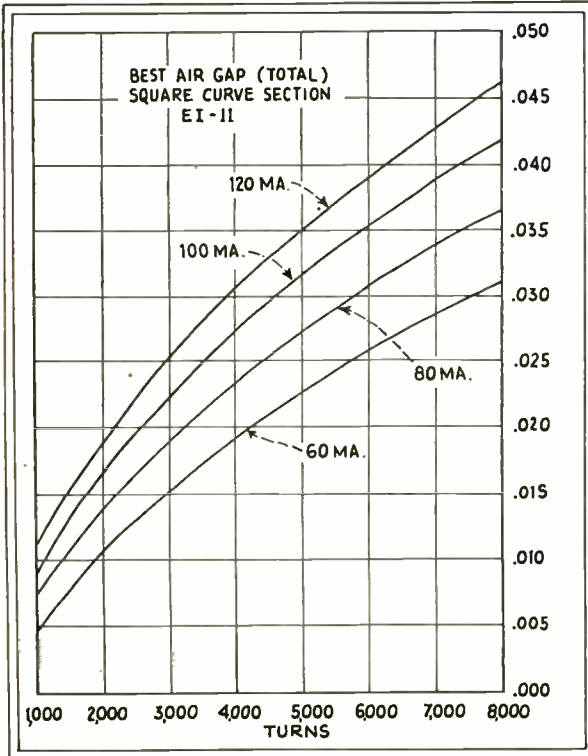
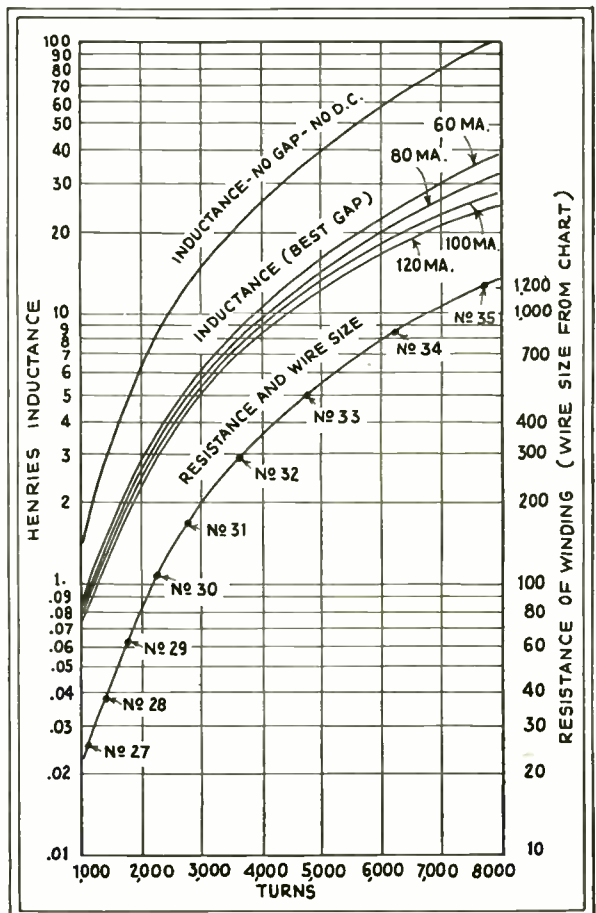

Fig. 3

For a given inductance and D.C. through the core, the number and size wire may easily be determined by means of the chart above. For an inductance of 20 henries, with 120 ma. through the core, 6,700 turns of No. 35 wire should be used on the core indicated in Fig. 2.



CONSTRUCTING ADAPTERS FOR

By F. L. SPRAYBERRY*

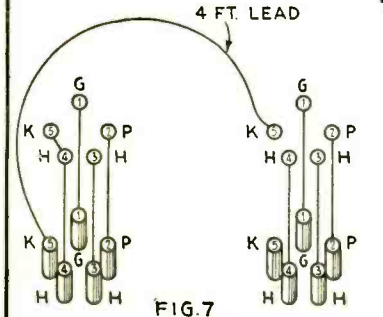
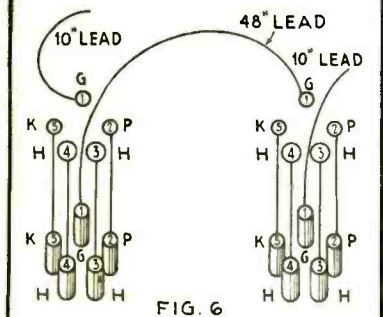
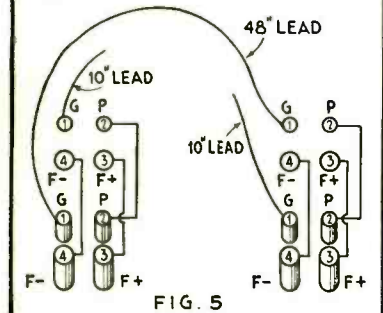
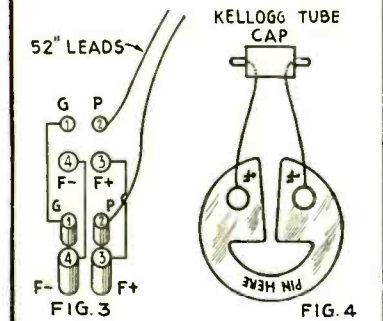
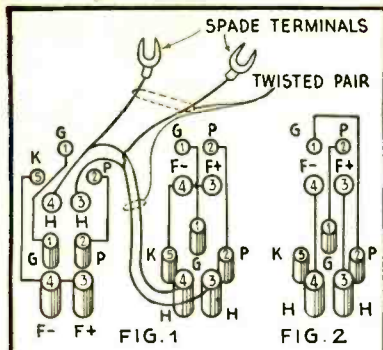

THE average Radio Service Man views with dismay the ever changing design of vacuum tubes. Each season sees new types differing in design from previous ones. For a long time the standard tube was of the three-element type, the base of which used four prongs. However, the public demand was for A.C. operation, and the four-prong tubes available at that time were not suited for operation on raw A.C.—this was particularly true of detector stages. Therefore, the five-prong tube emerged and became a commercial product. At least one was used in every A.C. operated receiver.

The next major change in design was the screen-grid tube. First there was the four-prong '22 type which was to be operated on batteries. It was not long until the companion tube for A.C. operation was released; this was known as the '24. The next change in radical tube design was the power pentode or '47.

The present season sees a variety of new tubes announced, several of which have a six-prong base. There will also be a tube having a seven-prong base. The next will be a —?

Radio testing equipment is, as a rule, designed to test the circuits of tubes in general use at the time that equipment is being manufactured. The manufacturers, of course, have no way of knowing the types of tubes that will appear in the future. As a consequence of the continued change in tube design over a period of several years, many fine pieces of radio test equipment have become obsolete, as they will not test the more modern tube circuits.

Many Service Men think that it is necessary to junk this equipment and purchase

new equipment. This is not strictly true. Two courses are open to owners of old test equipment. This equipment may be rewired (old testers may easily be rewired and brought up to date), or; the owner of such equipment may use standard adapters making it possible to test the new tube circuits. Rewiring is usually more expensive and for that reason many Service Men prefer to use adapters.

The purpose of this article is to inform owners of old test equipment just how they may bring their equipment up to date by using adapters. We shall cover each well-known line in the following order: Jewell, Weston, Supreme, Hickok, Dayrad and Readrite. Data is given as to the type of adapter required for each of the most popular testers of these makes. As these adapters are commercially available, they are best described by reference to their regular (Na-Ald) stock numbers.

Adapters for Jewell Testers

No. 942, Fig. 1, is used with the 133 and 133A testers. It permits testing from a five-hole socket. It is to be attached to the regular test plug.

No. 945J, Fig. 2, is used with models 133, 133A and 137. The plate and grid connections are crossed, the cathode being open. The adapter is placed in a five-hole socket and the test plug in the adapter. Refer to the instruction booklet for these testers for the further use of this adapter.

No. 952J, Fig. 3, may be used with all Jewell models. It is a UX adapter having a split-plate circuit with two 52-in. external leads for connecting a pair of headphones or a milliammeter in series with the plate circuit.

No. 949K, Fig. 4, is a UX adapter hav-

* Service Consultant, National Radio Institute, Washington, D. C.

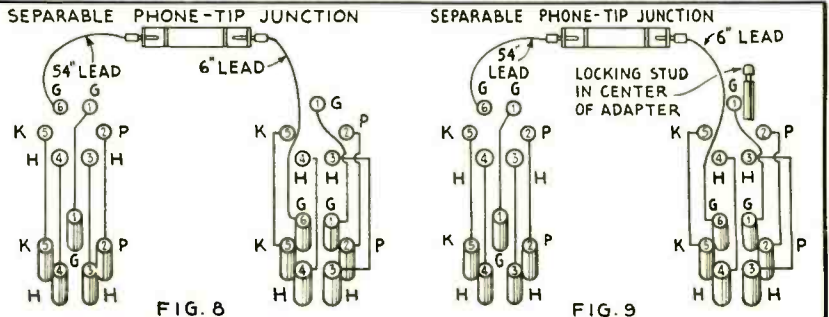

Twenty-nine out of one hundred eighteen adapters are described in this first of a series of practical articles.

TEST EQUIPMENT

ing 8-in. leads from both filament terminals. Used to test Kellogg "overhead filament" type tubes. It is inserted in the tube socket of the receiver. The filament leads are then connected to the overhead filament contacts of the receiver. May be used with Jewell Models 133, 133A, 198, 199, 408, 409, 444, 577, 578, 579, 581 and 660.

No. 932, Fig. 5, is a twin-adapter for testing the circuits of types '22, '32 and '34 tubes, using old-type 198, 199 and 581 testers. One adapter is placed on the test plug and the other in the tube socket of the receiver. The control-grid circuit is completed with the lead provided for that purpose.

No. 992, Fig. 6, is a similar adapter to adapter No. 932 except that it is made for types '24, '35, '36, '38, '39, '44 and '51 tubes. It is to be used with old-type 198, 199 and 581 testers.

No. 974, Fig. 7, is for testing the circuits of pentode tubes. This includes the types GA, LA, PZ, '33, 46 and '47. The adapter is of the twin type; one-half goes on the test plug and the other in the tester socket. May be used with the models 198, 199, 408, 409, 577, 578 and 579.

No. 965 DW, Fig. 8, is used for circuit tests on six-prong tubes such as the types 57 and 58. It is a twin-adapter, one-half of which is to be placed on test plug and the other in the tester socket. May be used with models 198, 199, 408, 409, 477, 578 and 579. By breaking the suppressor-grid lead this adapter may also be used to analyze the types 41, 42, PA and PZH tube circuits; connect the short lead to the control-grid stud on the analyzer plug and the long lead to the control-grid pin-jack in the analyzer.

No. 965DSW, Fig. 9, is for testing the circuits of types 57 and 58 tubes. It is a twin-adapter having split suppressor-

grid leads which are to be connected to the tip jacks provided on the Jewell 444. Also tests types 41, 42, PA and PZH tube circuits as directed above.

No. 964DS, Fig. 10, changes a six-prong plug to a four-prong plug, used with the Jewell 660. May also be used with any tester having a basic six-prong plug.

No. 965DS, Fig. 11, changes a six-prong plug into a five-prong plug. Used with the Jewell 660. May also be used with any other tester having a six-prong plug.

No. 982, Fig. 12, is used with all tube testers having a 2.5 volt socket. This adapter is made for testing the type 82 and 83 rectifiers in tube testers only; do not use with a set analyzer. It incorporates a switch for changing from one plate to the other and includes the necessary resistor. Use the type '45 socket in the tube checker for the 82 and the type '71A socket for the 83. Used with models 209, 210, 214, 534, 535, 536, 538, 540 and 597.

No. 944JY, Fig. 13, permits the reading of plate current for the 2nd plate of an '80 rectifier. May be used with the following Jewell testers: 198, 199, 209, 408, 409, 577, 578, 579 and 581.

No. 965CG, Fig. 14, may be used with Jewell Models 214, 533, 534, 535, 538, 540 and 597 tube checkers to test the types 41, 42, PA and PZH tubes. The adapter is to be inserted in the '36 socket, or any five-hole socket wired for a filament potential of 6.3 volts.

No. 954 KPC, Fig. 15, is for testing the GA, PZ, '33, 46 and '47 type tube in Jewell 209 and 210 tube checkers. It is to be inserted in a 2 or 2.5 volt (filament) four-hole socket.

No. 965KS, Fig. 16, is for testing the types 57 and 58 tubes in the following Jewell tube checkers: Models 209, 210, (Continued on page 245)

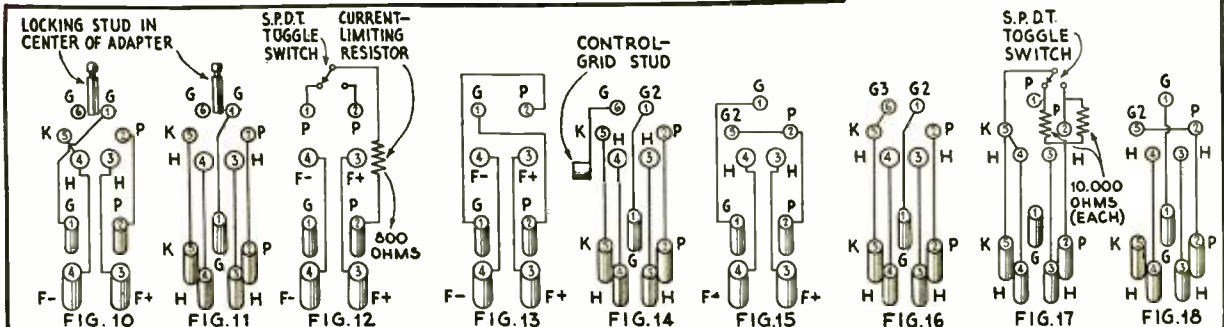
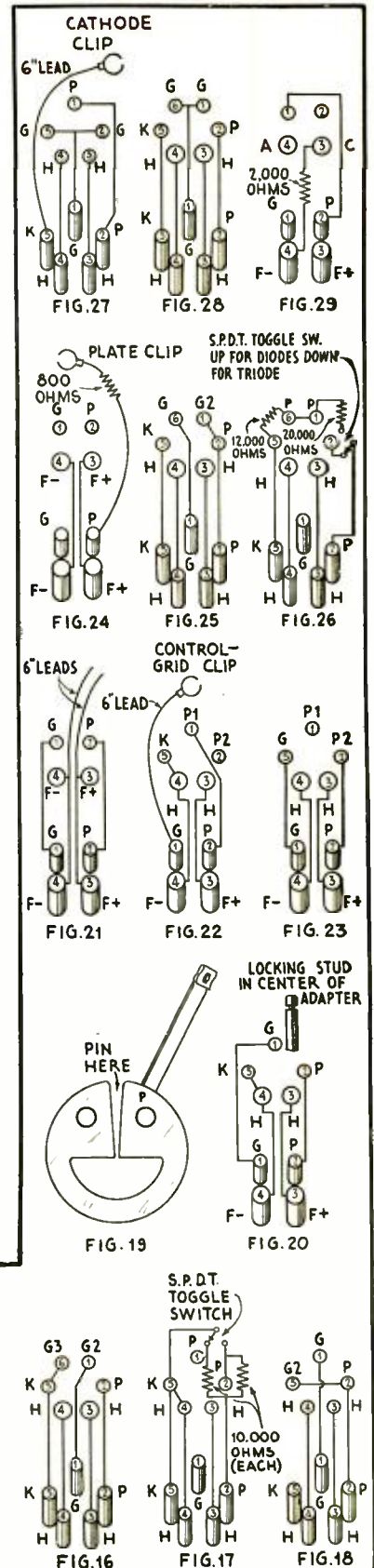

HOW TO REWIRE THE HI-Q 29 FOR THE NEW TUBES

By HUBERT LEE FRAZIER

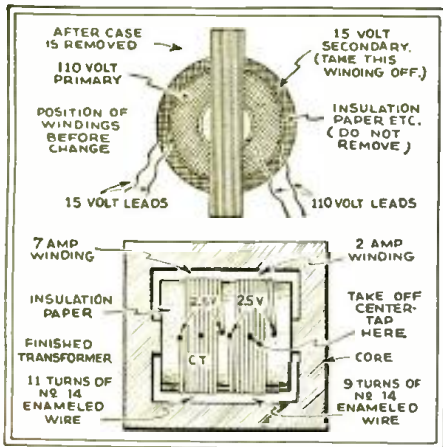

Fig. 3
Constructional details of the new filament transformer.

EVERYONE who owns one of the Hammarlund Roberts Hi-Q 29 receivers is familiar with their all around good performance. The R.F. coils are designed to be used with the high-gain type of radio tubes and the R.F. circuit is sufficiently filtered and shielded to permit the use of the new type tubes without adding any parts to it.

The Hi-Q "Master A.C." model is designed to use the 15-volt type of tube in all but the last A.F. stage. This tube is both difficult to obtain and expensive. Now, by making the changes described here, the operating cost and expense of tube replacement are reduced to a mini-

mum; also, the sensitivity and tone of the receiver are greatly increased. Figure 1 is a complete wiring diagram of the finished receiver and power supply, with all the parts marked for identification.

Disconnect the reproducer and power-supply unit from the receiver chassis and remove both the power-supply unit and the set chassis from the cabinet. Remove the tubes from the power supply unit and the set chassis, and begin the rewiring of the latter unit first.

Rewiring the Receiver

Remove the wires from the socket terminals marked P, F and F, connecting the wires taken from terminals marked F to the terminals marked P and G of Fig. 2. Next, remove the wire that runs from

the post marked C on the filament winding of the power pack to the bottom of the "C" bias resistor, and connect the wire that was taken from terminal P on the tube socket to the post marked C on the filament winding of the power compact. Now remove the wires from the posts marked F on the power compact, and run new leads from these posts to the socket terminals marked F. The filament transformer is now disconnected from the A.C. line cord. This transformer is either rewound according to instruction in Fig. 3, or is replaced with a new unit having one 2.5 volt, 2 ampere winding, and one 2.5 volt, 7 ampere winding. Mount the new or rewound filament transformer on the power supply unit and continue with the rewiring.

Connect the wires taken from the posts marked F on the power pack to the 2.5 volt, 2 ampere winding on the filament transformer. Upon tracing these wires they should be found to connect to the fahnstock clips numbered 5 and 6. These are the filament supply leads for the last A.F. tube. Connect the two wires taken from the filament secondary of the 15-volt transformer to the 2.5 volt, 7 ampere winding of the new filament transformer; from the center-tap of this winding connect a wire to the bottom of the "C" bias resistor. The center-tap of the 2.5 volt, 7 ampere winding connects to clip No. 10. Reconnect the primary of the filament transformer and the A.C. line cord.

The power supply unit is now ready for testing. Use a high-resistance type of

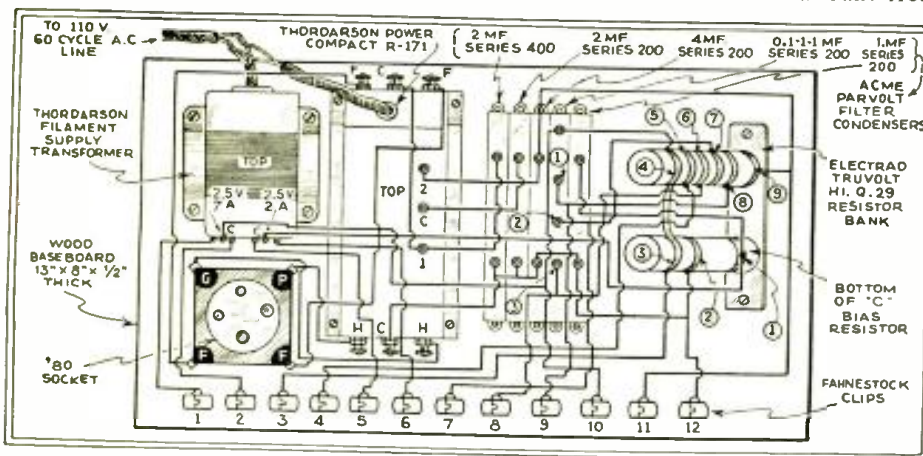

Fig. 2
Pictorial diagram of the revised HI-Q 29 receiver. A new filament transformer must be rewound as shown in Fig. 3.

(Continued on page 235)

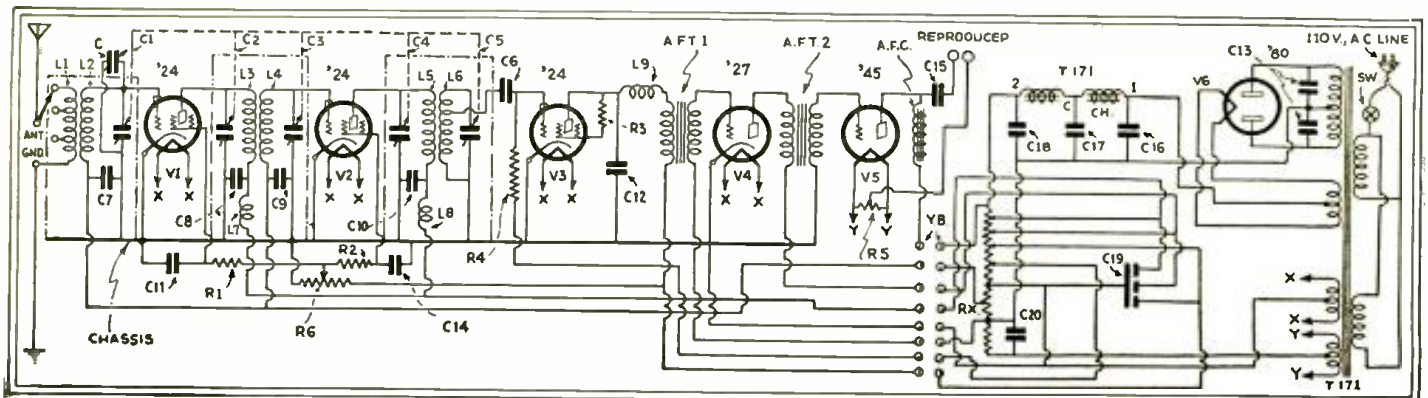
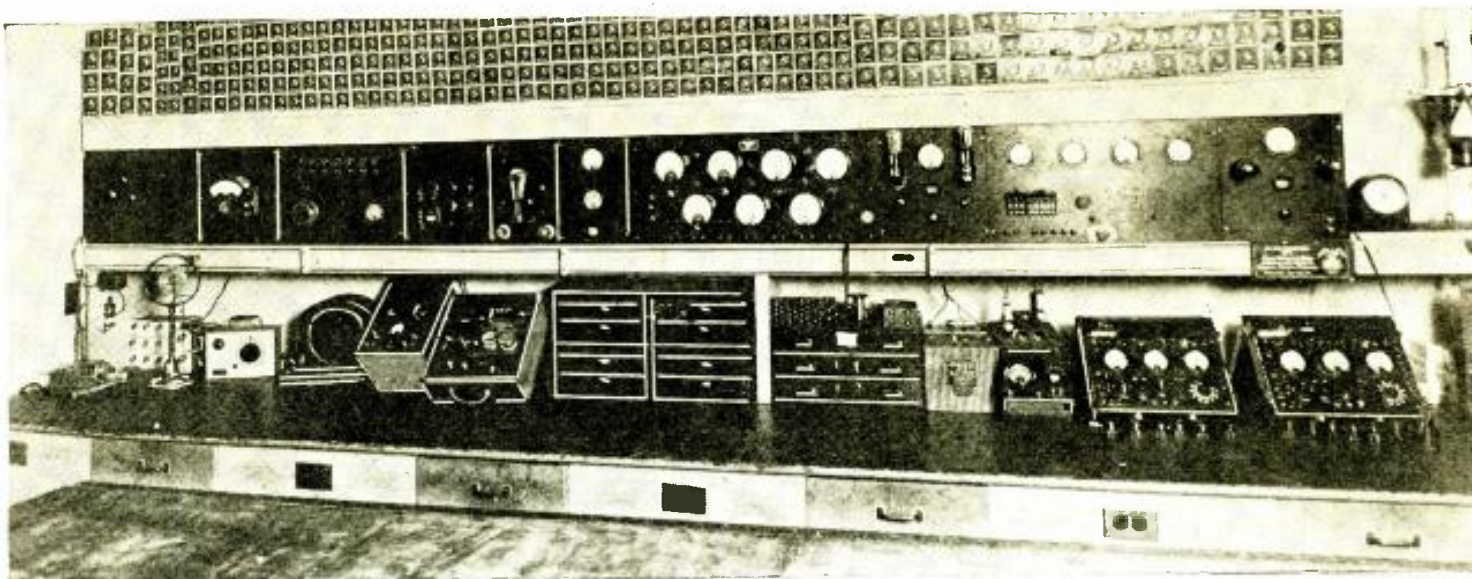

Fig. 1

Complete schematic circuit of the revised HI-Q 29. The old tubes have been replaced by the types '24 and '27.



PROFITS VIA THE SERVICE LAB.

By M. C. MANCILL

WE have found, after a thorough test over a period of six and one-half years, that a well-equipped service department is an asset to the radio sales department as well as profitable from a servicing standpoint. These statements are based on our operations as the radio service department and RCA Victor sales division of a music house which has been established for 27 years.

This laboratory, illustrated above, was built with the intention of expansion as business increased and as improved equipment was brought out. There are ten (10) panels in use, most of them being either 12 x 12 in. or 12 x 24 in. The connections are shown below. The first panel reading from left to right is blank; it was at one time a tube analyzer,

but was replaced with a Sylvania Vis-O-Meter.

Panel No. 2 is a decibel meter which is used to test speech amplifiers and audio systems in radio sets.

Panel No. 3 is a tube rejuvenator which was used in the early days for rejuvenating thoriated-filament tubes; it is still very useful, but to make it even more valuable, six UY sockets have been wired in for preheating, in conjunction with a Weston 565 analyzer (which is kept in the laboratory).

Panel No. 4 is a Leeds and Northrup Wheatstone bridge which is used for checking resistances and for making various other measurements.

Panel No. 5 is a neon glow tube with a self contained power supply delivering about 10 ma. at about 450 volts D.C. This

equipment is used for checking bypass and filter condensers.

Panel No. 6 contains an 0 to 150V. A.C. voltmeter and an 0 to 5 A. A.C. ammeter. These are used for finding the power consumption or current drain of the set under test. This combination is also very handy for locating intermittent power pack trouble.

Panel No. 7 is a Standard Jewell analyzing panel.

Panel No. 8 is a grid-dip instrument or resonance indicator which is used mostly for locating variable condenser short-circuits.

Panel No. 9 contains an 0 to 10 V. and an 0 to 250 V. D.C. voltmeter; also a 3-0-3 A. D.C. ammeter and an 0 to 100 ma. D.C. milliammeter. To these meters

(Continued on page 237)

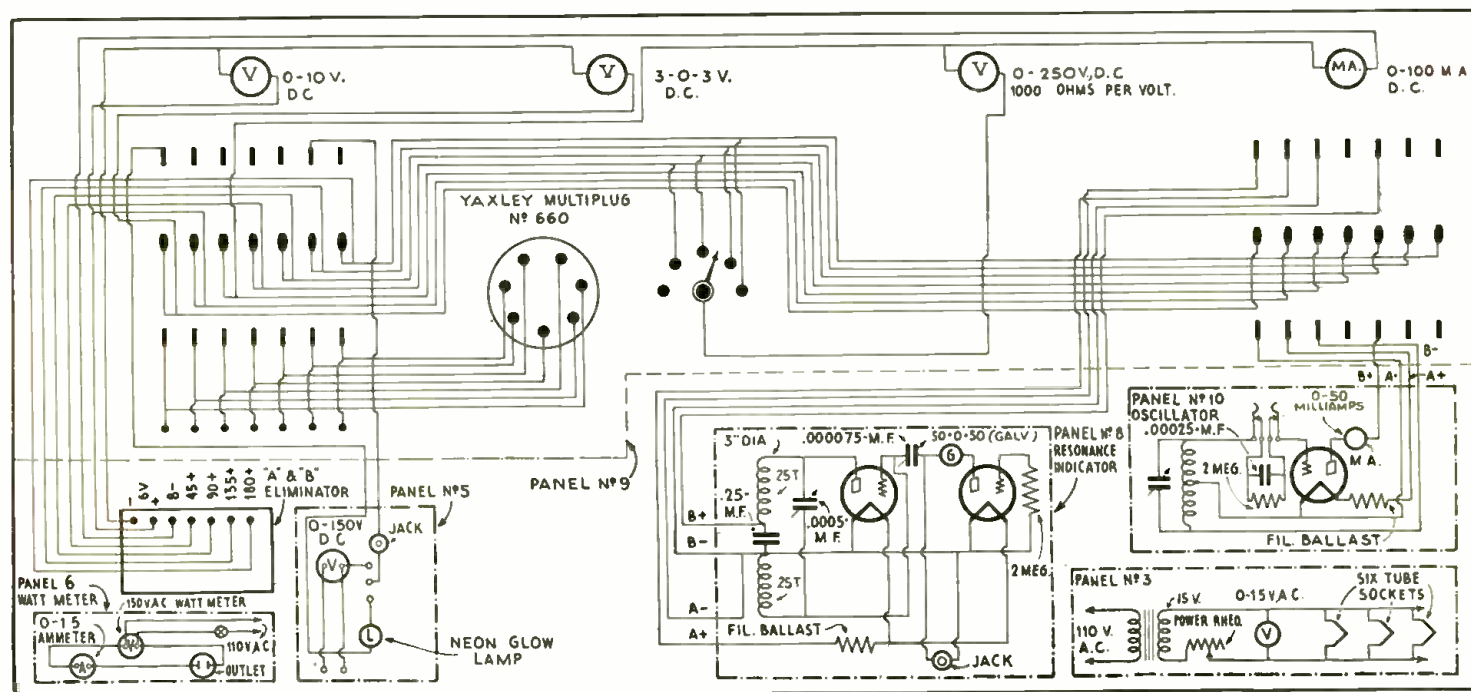

HOW TO REACTIVATE OXIDE-COATED FILAMENTS

By RAYMOND SHAW

Rejuvenated Tubes Stand Up

The author has been regularly rejuvenating A.C. tubes for over a year at this writing, and most of the tubes so treated are in service to-day. A charge of twenty-five cents is made for each tube and a clean profit of many dollars has been made during 1931. This has resulted in convincing customers of his ability as a radiotrician and so has sent him many new customers.

The time required to treat most tubes is from ten to thirty seconds and the first figure is sufficient for most tubes; however, it takes longer when treating heater-type tubes. The author wrote to the manufacturer of one of the best known tubes asking if A.C. tubes could be renewed. They replied "that there was no known method of reactivating A.C. tubes as the oxide-coated filaments would not stand high-flashing voltages without burning out." The latter part of their statement is true, but as to the first part, the author had been successfully rejuvenating A.C. tubes for over six months at the date of their letter!

The Theory of A.C. Rejuvenation

The average vacuum tube has four important constants, electronic emission, plate impedance, amplification factor (μ), and mutual conductance. All of these constants are governed by one major element—the condition of the filament. If the physical structure of the tube elements have not been altered and the filament is intact, but does not emit the necessary number of electrons, then the tube cannot correctly function and is generally spoken of as having come to the end of its life.

Now if we could force the filament or cathode to emit the proper number of electrons, then its life would be renewed; this is exactly what we will do. Most Service Men are perfectly familiar with reactivating D.C. tubes wherein no plate or grid voltages are applied; but to reactivate A.C. tubes, high grid- and plate-voltages are necessary and normal filament voltages are used on some tubes while others require twice their normal filament voltage. In A.C. tubes, the abundance of electrons necessary for their operation is due to an oxide coating on the filament or cathode, depending upon the type of filament or heater used in the tube. When this oxide coating is burned away, sufficient electrons are not emitted for satisfactory operation and the tube is useless. Application of high grid and plate voltages will overcome this condition in the majority of cases by reconditioning this oxide coating and so renew the tube's life.

Construction of the Rejuvenator

In an emergency, any high-voltage transformer (preferably one with a 700-volt secondary) can be hooked-up, and the job can be done without switches of any kind. But it will more than repay the cost of parts and time to build a permanent hookup if carefully assembled and housed, either in a portable form or in any small box for shop use as shown in Figs. A and B. An R.C.A. model 16 cabinet will do very well, as an A.C. oscillator may also be placed in it and operated from the transformer used for the rejuvenator.

In the portable outfit shown, the laminations of a defective R.C.A. model 60 power transformer was used. First heat the



Fig. A
Front view, showing the location of the controls.

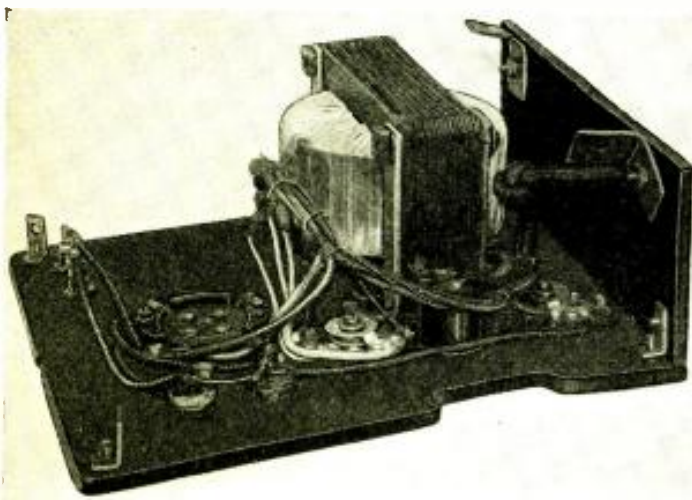

Fig. B
Rear view showing the location of the component parts.

CAN hear some of you Service Men saying that you have no interest in rejuvenating tubes since their cost has dropped to the present low level; also, that you can make more money selling new tubes—but:

First, how many of you Service Men, on a hurry-up job, have found one or more weak tubes in a radio set and discovered that your stock in that kind of a tube was low? Of course, this should never happen, but it does! How handy it would be to be prepared to build up those weak tubes;

Second, how many of you have taken a job where the customer's finances are low (and many are during this depression) and the job must be done at the lowest possible figure at which you can make a profit or you don't get it?

Third, how many of you would like to cut down your tube replacement costs when reconditioning sets for resale?

Fourth, also, how many of you have an unsatisfied customer whose ninety-day guarantee has expired? My answer is to rejuvenate, if the tube is weak, and impress your customer with the fact that you know a thing or two.

To my knowledge no article on the subject of A.C. rejuvenation has been in print and while it is known to a small number of radiotricians, it has been jealously concealed from Service Men at large.

While tube reactivation is not new, nevertheless it is generally conceded that the process is not a very successful one with oxide-coated filament tubes. In this interesting article, the author describes how to build and use a device that really works—the editors made exhaustive tests—and its cost is about five dollars!

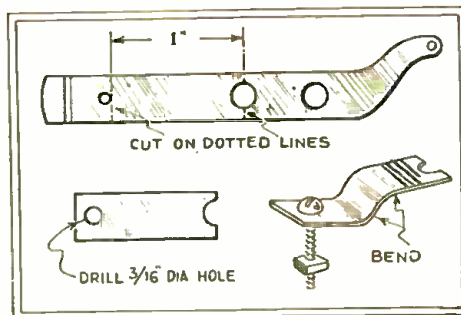

Fig. 3
Breaking apart the phone jack.

cased transformer (turned upside down) over a flame and place it on two wooden strips in a pan covered with an old can. (See RADIO-CRAFT for April, 1931, page 492). Uncase the transformer and as soon as the remaining compound begins to congeal, remove it; now carefully remove the laminations. Place them in gasoline and leave over night to loosen the tar coating; then wipe clean with cloth. If the primary winding is intact, save it. In any case, be sure to count the turns of the 2.5- and 5-volt windings so as to know the turns-per-volt required when rewinding.

The high voltage winding was burned out in my case, so it was rewound with No. 28 enameled wire and tapped for 200, 325, and 750 volts. (See RADIO-CRAFT for Sept. 1931, page 166 on the "Design of Power Transformers.") Then wind on the filament windings, tapping at 1.5, 2.5, 5, and 7.5 volts, as shown in the schematic circuit of Fig. 1.

Special Switches

While high grade push buttons were used in the portable outfit, the author prefers special constructed switches (SW 1 and SW 2 of Fig. 1) as very rapid-acting switches are required. A miniature D.P.D.T. knife switch was used because no D.P.S.T. switch was in the "junk box." Refer to Fig. 2. The cross-bar was removed. Two fiber rods $\frac{1}{4}$ x $1\frac{1}{2}$ inches were slotted and drilled for rivets made from No. 18 copper wire. These rods made excellent handles when attached to the switch blades; the miniature switch was then mounted on a piece of bakelite. A phone jack was torn down and two of the springs were cut to 1-inch lengths, as shown in Fig. 3.

How to Apply High Voltages

In general, use the lowest possible voltage on grid and plate that will give results. The high voltage to the grid and plate must be flashed; never use voltages so high that the filament turns white and emits a large number of sparks, because it will burn out. Do not flash high voltages long enough or so rapidly as to turn the plate of the tube red. As a general rule, begin using flashing voltages of $1\frac{1}{2}$ times the tube's normal plate voltage and, by steps, raise it to 2 or $2\frac{1}{2}$ times normal

voltage. This may sound very difficult but it really is not, for few tubes burn out except where excessive voltages are used and then the operator is the only one to blame. *But do not become discouraged if you burn out the filaments of the first few tubes.*

Table of Voltages to be Used

The author has successfully treated the following tubes at the voltages as given:

Type of Tube	Voltage of Filament	Voltage flashed on Grid and Plate
'12A	5	200-400
'71A	5	200-400
'26	1.5	200-400
'30, '31, '32	2.5	200-400
'45	2.5	400
'50	7.5	400-600

'27, '24, '35, '51; apply 5 V. approximately one minute and test before applying grid and plate voltages; then apply 200-400 volts if necessary.

Some '80's will respond to the treatment; especially where one plate shows full emission and the other, low.

Color the Important Thing

Set your apparatus up in a dark place, or at least shade the tube from strong light, for you must watch the color changes brought about in the spaces inside the plate and surrounding the grid and filament. Most tubes show a blue-green color in the above mentioned space when the desired results are obtained. Better to test the tube frequently than to over-do the process. Those tubes that develop this blue-green color are the easiest treated. Some tubes will not develop this color but will show a bluish color not very pronounced and still will show an O.K. test. Experience, only, will fix in your mind the colors required to develop full emission from the tube.

Heater-type tubes of the 2.5 volt group should be treated with 5 volts on the filament from $\frac{1}{2}$ to 3 minutes and then tested
(Continued on page 250)

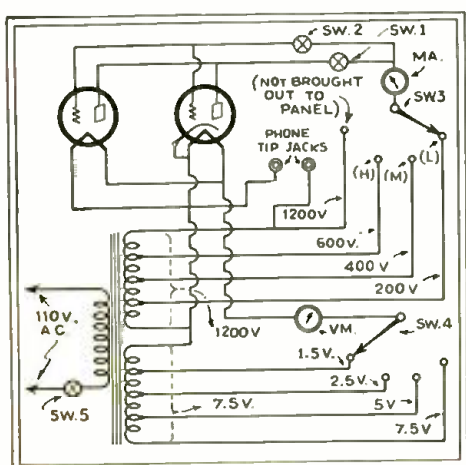

Fig. 1
Schematic circuit of the reactivator.

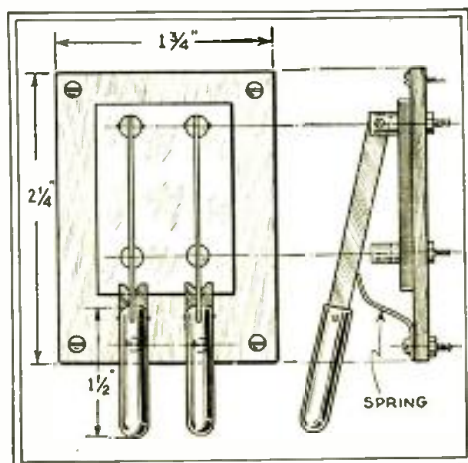

Fig. 2
Construction details of the knife switches.

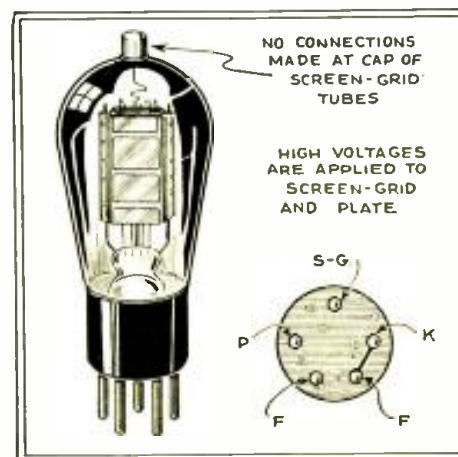

Fig. 4
How the five-prong tubes are reactivated.

THE SERVICE MAN'S FORUM

Where His Findings May Benefit Other Radio Technicians

SERVICE MEN PREFER RADIO-CRAFT

Editor, RADIO-CRAFT:

I have just purchased my July issue of RADIO-CRAFT and I want to say it's a dandy. Just the information and data that most Service Men would like to have.

I am one who buys his radio magazines after a glance through to see "What it has for the Service Man."

The Editorial, more dope on ohmmeters, circuits, latest equipment, two new tubes, how to use a set analyzer, operating notes, the Service Man's Forum, a simple oscillator, RADIO-CRAFT kinks, information bureau and, especially, Mr. Silver's article on audio systems—and, just what I have been waiting for, a tube table.

It would make me go plenty far out of the way to get the July issue if I didn't purchase it next door.

I spread the good news around and also have been asked, "Did you get the July issue of RADIO-CRAFT?"

There are three magazines most Service Men buy: RADIO-CRAFT, Radio News and Radio Callbook. Whichever has the most data or, we might say, dope for the Service Man, is taken along to the shop.

I feel that the majority of Service Men buy RADIO-CRAFT, if they have not already a subscription. So I can see, in my light, that if you continue putting to press a magazine such as your July issue you certainly will have us all buying your magazine every month.

Remember, radio is our bread and butter and we are not interested in experiments, etc. We want more issues just like your July number.

I write this as a matter of information to you and for my own lookout; also, I can safely say, the lookout of the majority of men who are in the service business.

Nothing is more disgusting than to purchase a radio magazine and find that three-quarters of it are devoted to foolish experiments for some office man in his leisure hours.

Well, I bet there are plenty of us that have your tube chart enclosed in cellophane and hanging over the bench for reference.

AL. McNEILL,
2315 E. 75th St.,
Chicago, Ill.

(Thanks for the bouquet. Although we try to present to the Service Man new and original material on every phase of this branch of radio which might enable

him to increase his income, it should be realized that there are thousands of experimenters who have no commercial interest in radio and to whom the thrill of watching experimental ideas put into practice means more than the lure of gold. A few general-interest articles, and miscellaneous kinks serve to keep these folk posted on "doings" of interest to them. Let's all shake hands, in RADIO-CRAFT, "for the good of the order."—Editor.)

"RAH! RAH! CORRESPONDENCE SCHOOL!"

Editor, RADIO-CRAFT:

This is to bridge the space between us and to pat Oscar Prescott, of Vinton, Iowa, on the back. The sum total of my radio knowledge was gained through a correspondence course, augmented, of course, by keeping up to date via the monthly issue of RADIO-CRAFT.

A short time ago a Heritage radio set (U. S. Radio & Television Corps' old model 80) was brought in to me to fix; the thing was deader than any door nail you ever saw, as far as reception was concerned, although the speaker sounded

alive. Pulling out the first R.F. tube and sticking the aerial into the plate receptacle of the socket produced music, thus localizing the source of trouble. Finding it was a different thing.

Everything checked O.K. down to the volume control (which is a potentiometer across the input—and in these models with a serial number above 5050 the aerial connects to the aerial). A few minutes thinking gave me my answer—the slider was not insulated from the shaft. The shaft, in turn, made contact to the chassis through a small metal plate used to support the unit. Therefore, the aerial was completely grounded. I questioned the owner as to other Service Men working on it. Here is the rub:

The owner, fearing to trust his radio to a correspondence school man in a village of 1,200 people, had taken it to a high-powered, well advertised service shop in Appleton, 21,000 population, 40 miles away. The owners of the shops are graduates of Wisconsin U. They had replaced the original control with an Electrad unit, but had overlooked that one point, and the set came home worse than when it left. Evidently, they had not tested the set after making the repair.

One of several things I have done was to cut a mounting plate out of heavy fiber and, presto—the job was done.

All this is no argument against the residence school, but just the same, you can get to know your radio from a correspondence course if you really study the material furnished you. At least, you can learn fundamental principles and after that, it is up to you. So, therefore, I say, "Rah! Rah! Correspondence School!"

L. W. NYGAARD,

Box 36,
Gillett, Wis.

(And, we might add, three cheers for "horse sense"—for who in this day and age would expect to repair a radio set and then turn it out of the shop without running an operating test on it! Apparently, population hasn't a thing to do with reasoning ability. However, the fact that the receiver left the shop without being tested may have been an accident. It so happens that the Service Men may have thought that the set was tested when, in fact, it was not. Accidents will happen, even in the best of families, and no one can be blamed for making a mistake once in a while; for the man who never makes a mistake never does anything.—Editor)

THE Official Radio Service Mens' Association, sponsored by RADIO-CRAFT, invites all Service Men who are not members of the Organization to write for an application blank. It is the official service organization of this maga-



Official lapel button of the O. R. S. M. A.

zine and is maintained solely for the interests of Service Men. Membership cards are issued upon passing a written examination which is forwarded by mail. Write for yours today. The O. R. S. M. A., 98 Park Place, N. Y.

CALL YOUR NEIGHBORHOOD
RADIO DOCTOR
WHEN YOU HAVE RADIO TROUBLE

ALL MAKES OF RADIOS REPAIRED, TESTED, INSTALLED AND IMPROVED — AERIALS ERECTED, TUBES TESTED, ETC.

Prompt, Reliable, Honest Service

Not Connected With Any Store, We Don't Sell Radios—We Fix 'Em

GILBERT W. CRAMER

39 BELLWOOD AVE., BELLWOOD PHONE BELLWOOD 4857-J

Keep up telephone number 4857-J—don't let it go! YOU'RE RADIO is your best kept secret!

PRICES FOR SERVICE

Home Call \$1.00
Most cases of radio trouble can be fixed on one call. (Phone areas.)

Repair charges will be kept as low as possible.

We offer a personal, neighborhood repair service.

We have no new sets to sell—repairing is all we do.

Parts and tubes are cheaper now than they have EVER been.

Sunday calls at same rates.

We'll call at any time convenient to you.

References furnished if desired.

Benefit by our eight years experience in repairing.

SAVE THIS CARD

Printed on opposite sides of yellow cardboard measuring 3 1/4 x 5 1/2 inches.

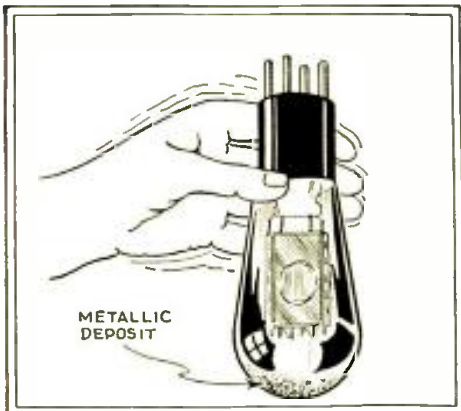

Fig. 1
Shake well before testing.

Prize Award

HOW OLD IS THAT TUBE?

By Leon J. Fox

AT the present time there is no way to tell the age of vacuum tubes. When the Service Man replaces the tubes in a receiver he wants to be sure that they will perform a reasonable length of time in order to satisfy the customer. While there are old tubes in the set that test O.K., the Service Man does not know how long they will last. In many cases he may get a recall and will have to replace these tubes free of charge.

Upon turning the doubtful tube upside down and tapping gently, it will be noticed that there will collect a deposit coating from the filament. After a careful examination of a number of tubes of known age, the quantity of this coating will determine how long the tube has been in operation. The heater-type tubes will show less coating. See Fig. 1.

I have found that it is a good idea to show this defect in the old tube to the customer as a reason for replacement.

CURING RECEIVER HUM

By Randolph Mutschelknaus

NO doubt many Service Men have found sets using electrolytic condensers that will operate all right for half an hour or more, then develop an abnormal hum; and after trying everything the manufacturer recommends to cure this hum, have replaced the electrolytic condenser and thus cured the trouble.

In the event that a replacement unit is not available, the Service Man may be interested in the simple procedure followed by the writer in eliminating this hum and giving the customer service until a new condenser of longer life can be connected into the set.

Drill a small hole in the top of the condenser (through the hard rubber), as

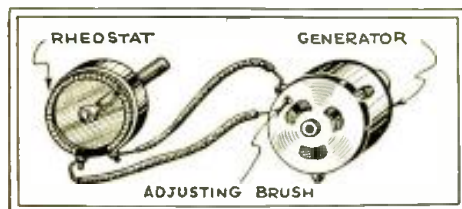

Fig. 4
A very neat device for regulating the charging rate of the car battery.

SHORT CUTS IN RADIO SERVICE

\$10 for Prize Service Wrinkles

Previous experience has indicated that many Service Men, during their daily work, have run across some very excellent Wrinkles, which would be of great interest to their fellow Service Men.

As an incentive toward obtaining information of this type, RADIO-CRAFT will pay \$10.00 to the Service Man submitting the best all-around Radio Service Wrinkle each month. All checks are mailed upon publication.

The judges are the editors of RADIO-CRAFT, and their decisions are final. No unused manuscripts can be returned.

Follow these simple rules: Write, or preferably type, on one side of the sheet, giving a clear description of the best Radio Service Wrinkle you know of. Simple sketches in free-hand are satisfactory, as long as they explain the idea. You may send in as many Wrinkles as you please. Everyone is eligible for the prize except employees of RADIO-CRAFT and their families.

The contest closes the 15th of every month, by which time all the Wrinkles must be received for the next month.

Send all contributions to the Editor, Service Wrinkles, c/o RADIO-CRAFT, 98 Park Place, New York City.

illustrated in Fig. 2: turn on the radio set and fill the condenser with distilled water until the hum stops. Then, add enough water to raise the solution level in the condenser about 1/2-in. or more. Seal the hole in the condenser top with wax and the set is ready for many more months of service.

Be careful not to touch the condenser connections or the water container (if it is metal), while filling, or you may receive a shock.

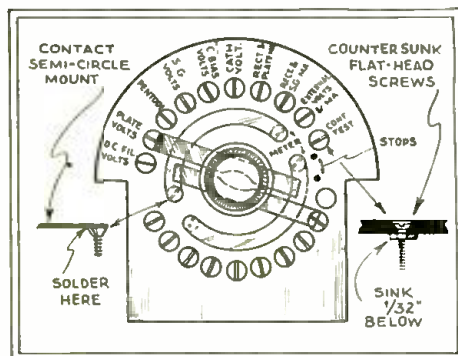

Fig. 2, right.
Filling the electrolytic condenser with water, similar to a storage battery, may reduce hum.

MAKING A BI-POLAR SWITCH

By G. A. Sherwood

IN Fig. 3 is illustrated the manner in which the writer made a successful bi-polar analyzer switch to meet an immediate need.

A series-parallel switch; two pieces of copper; a small piece of 1/4-inch bakelite; twenty, 1/2-inch, 6-32 flat-head brass screws; four, 3/4-in. flat-head brass screws; and two stop pins complete the list of parts. Countersink the flat-head screws 1/32-in. below the panel to prevent the contact blades shorting two of the contact points. The switch made by the writer and illustrated in the figure had over-all dimensions of 4 1/4 x 4 1/4 ins.

COMPENSATING CAR-RADIO BATTERY DISCHARGE

By L. Z. Tucker

THE writer, specializing in automotive radio service, has experienced difficulty in keeping car batteries correctly charged, due to the fact that the cars often make long runs, thus making it necessary to adjust the generator (normally adjusted to compensate for drain due to the radio set being operated on short runs) so as not to over-charge the battery.

To make generator adjustment easy for the car operator, I now mount on the cowl a 6-ohm rheostat of heavy-duty type and run two wires to the generator, as shown in Fig. 4. This resistor is connected into the circuit by breaking the field coil lead to the adjusting brush, completing the circuit through the variable resistor; then, advance the third, adjusting brush on the charger to its full limit. After this, the rheostat will afford a charging range of 2 to 20 amperes.

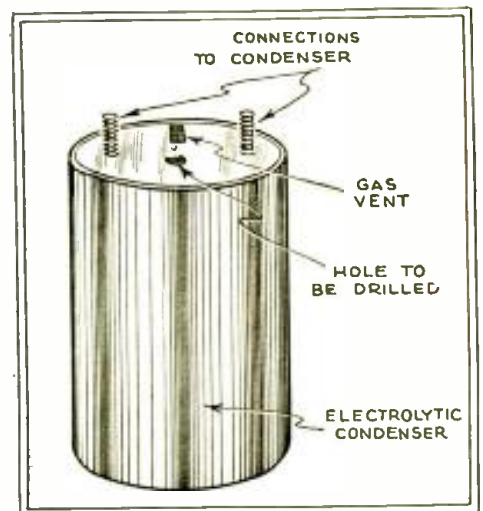

Fig. 3, above.
A home-made switch for that analyzer or tube tester is described.

THE ANALYSIS OF RADIO RECEIVER SYMPTOMS

OPERATING NOTES

By BERTRAM M. FREED

THE servicing of radio receivers is becoming more complex with each succeeding day. Manufacturers are releasing new models so quickly that the Service Man has all he can do to keep abreast of the different tube designs, tube coupling devices, and automatic volume control systems. Each problem has its own solution and the only saving feature is the fact that the same faults are found in each model, the latest model receivers providing as much food for thought as their predecessors.

Philco 91

In a number of the new Philco 91 twin-speaker receivers, the complaint of "no control of tone" has been met. The same four-point switch as used in previous Philco models is employed here, as shown in Fig. 1. With the switch in the "brilliant" position, there are no condensers in the plate circuit of the first audio amplifier tube. As the switch is placed in the next position, a condenser is added to the circuit. The third and fourth positions each add a condenser, so that in the "bass" or "deep" position, there are three parallel condensers connected from the plate of this stage to chassis. However, in these several receivers, as soon as the tone control was switched from "brilliant" to the next step, the tone became so muffled and deep and the volume dropped so much that it was impossible to understand any voice broadcast clearly.

In the first set where this condition was encountered, the tone control was thoroughly checked. Each condenser was tested separately and each proved satisfactory! A new tone control was then installed and when this did not help, the original unit was connected into another chassis and it performed in correct manner, creating a puzzle of "how come?"

Upon a happy thought, the Philco '37 tube (this receiver employs automobile-type, 6.3-volt tubes, discounting the '80 rectifier) in the first A.F. stage was replaced and the tone control worked splendidly. Despite the fact that the tube had been checked previously and found to be normal in all respects, it would not function in this stage; in the oscillator stage, it worked perfectly. To satisfy curiosity, the tube in question was placed in a number of receivers of the same model and the same result was obtained, "no control of tone." All in all, six of these tubes have been found. When this condition is encountered, all that is necessary is to switch the sockets of the oscillator and first A.F. tube.

After the Philco 91 has been in operation for a short time, the dial may be found to slip. This receiver makes use of a dial-cord whose tension, or slack, is taken up by a coil spring. It is only necessary to move this spring up one or two steps in the series of notches cut out in the dial to remove any slipping condition. Rosin, or warm tallow from an

ordinary candle, rubbed into the cord will also help to eliminate this fault.

Philco 90

The Philco 90 receiver, in the pentode-output models (See the circuit on pg. 160 of the September, 1932, RADIO-CRAFT) has furnished grounds for much distress to many Service Men. The chief complaints with this model include not only fading or intermittent reception, as previously described, but also noisy reception. Both of these effects are caused by the A.F. coupling condensers.

This receiver utilizes three of these bakelite encased units: one, coupling the diode detector to the detector-amplifier tube; the second, coupling the plate of the detector-amplifier tube to the grid of the first A.F. tube; and the last, coupling the grid of the pentode to the plate of the first A.F. tube.

Their value is given as .01-mf., but 1-mf. tubular condensers have been used for replacement with much success when the former were not at hand, the value not being critical. In several cases, however, where the 1-mf. condensers were used, it was found necessary to replace the first A.F. grid-leak resistor and sometimes, the pentode grid-leak resistor, with 100,000-ohm units to eliminate the tendency to motor-boat.

In this same model, the second coupling condenser has been found mainly responsible for noisy reception, although, on

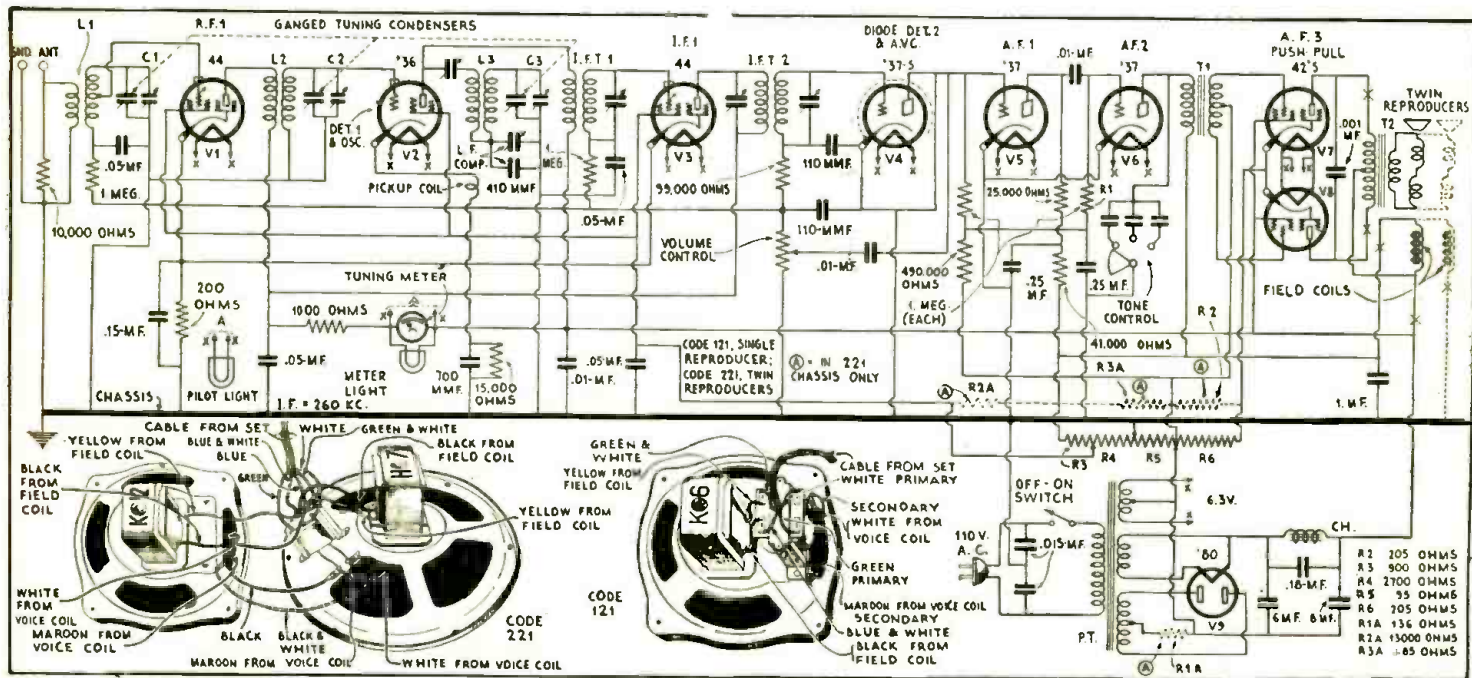

Fig. 1

Schematic circuit of the Philco 91 receiver. The volume control has a value of 350,000 ohms; the tone control has one .05-mf. and two .01-mf. condensers; the field coils, a resistance of 3,200 ohms; and the filter choke, a value of 285 ohms.

two occasions, the third was the offending member. This may be eliminated by applying the soldering iron to the lug of the condenser. Usually, it will be necessary to replace the unit. Any method may be pursued in determining the noisy condenser, although the writer has found that removing each one, in turn, from the circuit, and substituting a new condenser is the most certain and quickest procedure.

Zenith 91, 92

The next receiver to be considered is the Zenith 91, 92 superheterodyne; in chassis below Nos. 373, 334 and 301, 394, respectively, we experienced no end of trouble. The symptoms in this case, are: (a) marked fading; (b) no dip-action on the tuning meter, and; (c) little or no response on the local side of the local-distance switch. A glance at the schematic detail, Fig. 2, will disclose two resistors, R1, R2, which are connected in series across the D.C. voltage output as bleeder resistors, the values being respectively, 2,800 ohms and 3,600 ohms. These carbon units, not capable of withstanding the load placed upon them, are the source of the entire complaint.

These resistors break down under load and the electrical values vary, resulting in the above-mentioned complaint. The only remedy is replacement with resistors whose rating is 10 watts or more. The defective units are easily located, as they are the two largest resistors mounted upon the resistor strip. The other means of identification will be the discolored or burnt portions to be found on the resistors as well as a collection of dust under the units, such as is found under beds and dressers in a bedroom, when the floors have been neglected for a few days. (!)

It must be mentioned that the last lot of this model that was released incorporated wire-wound resistors of sufficient carrying capacity in place of the troublesome carbon units.

Majestic 61

On service calls marked "Majestic 61," a common complaint is "no reception," or "dead." A check will often reveal no plate voltage on the I.F. tube or first-detector and very low plate voltage, if any, on the other tubes.

The use of the ohmmeter will show an almost full short-circuit between the I.F. plate or first-detector plate—as the case may be—and chassis. Unsoldering wires will finally localize the trouble to the primary of either one of the two I.F. transformers. A low-range ohmmeter, capable of measuring the D.C. resistance of the I.F. primary, will show the "short" to chassis to be at the "B+" end of the primary. The circuit is Fig. 3.

This short is caused by the breakdown of the bypass condenser connected from the "B+" side of the primary to the shield can of the transformer. The condenser is sealed in pitch within the riveted shield can of the I.F. transformer, and before the defective unit may be removed from the circuit, it will be necessary to drill out the rivets (so that the shield can may

be disassembled), and to melt out the bypass condenser. The transformer and shield are then re-assembled; a bypass condenser of sufficient voltage rating is then connected externally across the correct terminals.

No doubt, it is much simpler to replace the I.F. transformer, but this is a somewhat expensive proposition if a genuine replacement is desired, although an ordinary high-gain I.F. transformer, peaked at 175 kc. may be employed, together with an external bypass condenser.

If the entire shield is carefully insulated from the chassis and the transformer mounted on the chassis by means of insulated bushings or an insulated strap, this will disconnect the shorted condenser from the chassis. The secondary return of the first I.F. transformer does not connect to the shield can but connects to the A.V.C. circuit externally; the trimmer condensers have one side of each connected to the shield can and the other side connected to the plate and grid of the primary and secondary windings, respectively. The grounded sides of each condenser may be disconnected, and re-connected to the "B+" side of the primary and the grid return of the secondary, so that each trimmer is connected across and tunes each respective coil in conventional manner as depicted in Fig. 3.

Servicing this model, recently, two instances were encountered where no signals could be obtained unless the A.V.C. type '24 tube was withdrawn. When this was done, the receiver performed with

full sensitivity but without any control of volume. The schematic showed the function of the A.V.C. tube to be that of varying the control-grid bias of the R.F., first detector and I.F. tubes.

As a similar experience with a Radiola 67 (described in the July, 1932 issue of RADIO-CRAFT, page 33, where an inoperative receiver would perform without the A.V.C. '27 tube) inspired further tests, the control-grid circuit of the A.V.C. '24 was checked.

The wire connecting to the control-grid of this tube runs through a hole in the chassis and is soldered to a small terminal on a square, insulated strip directly alongside the socket. A green wire, which should have been soldered to this lug was moving freely about in the joint

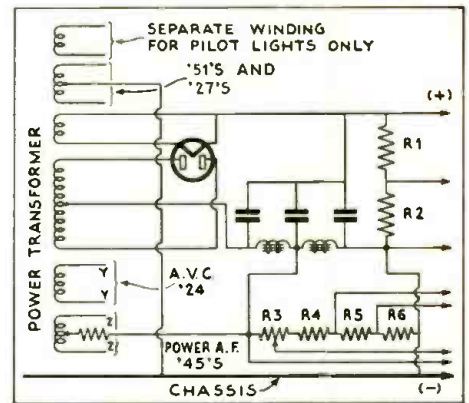

Fig. 2
Schematic circuit of the Zenith 91, 92 receiver, used in chassis Nos. 373, 334, and 301, 394.

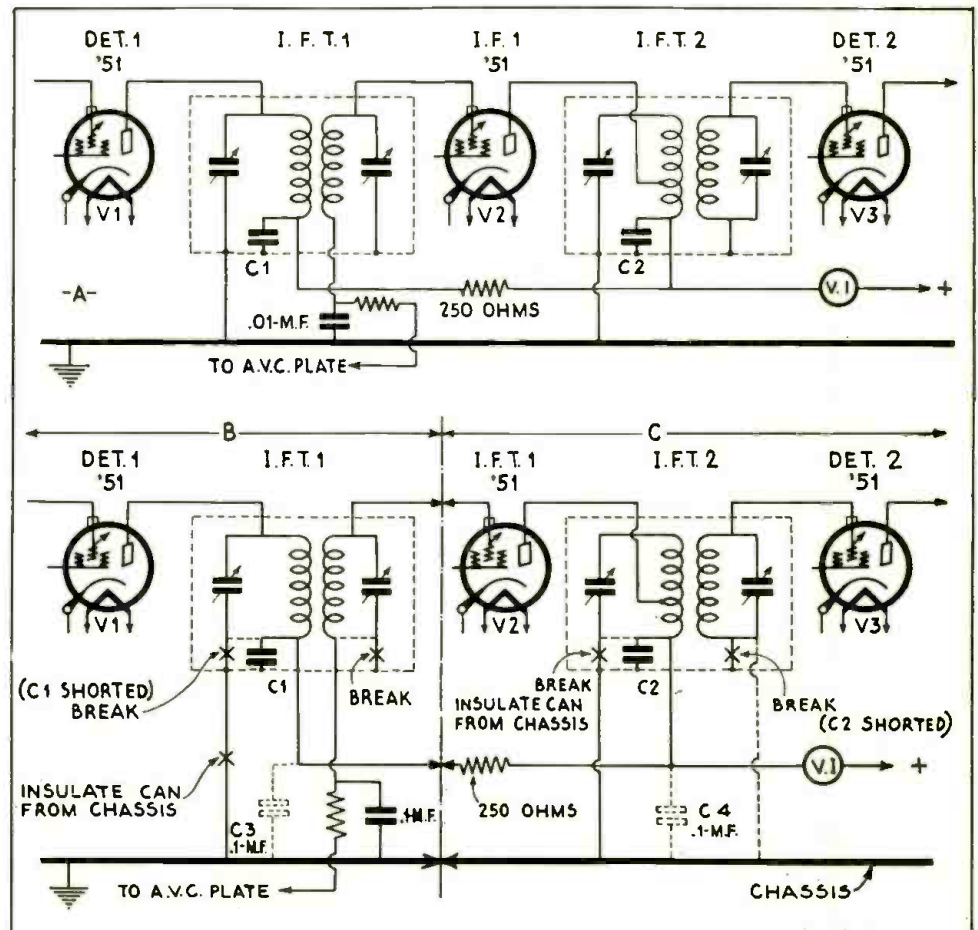

Fig. 3
The Majestic 61. A shorted I.F. transformer primary causes trouble here.

GALVIN MOTOROLA MODEL 61 AUTOMOTIVE RECEIVER

(Incorporating a type 85 duodiode-triode as a combination second-detector, automatic volume control and first A.F. amplifier.)

This automotive receiver incorporates the following tube combination: Tube V1, type '36 screen-grid as an R.F. amplifier; V2, type '39 variable-mu R.F. pentode as a combination oscillator and first-detector; V3, type '36 screen-grid I.F. amplifier; V4, type 85 duodiode-triode as a combination second-detector, automatic volume control and A.F. amplifier; V5, type 41 high-mu special automatic pentode second A.F.

High voltages are obtained from the storage battery of the car by means of an interrupter system and step-up transformer, in the manner described in the Sept. 1932 issue of RADIO-CRAFT, pg. 152.

Following are the values of the components of this modern radio set: Condensers C1, C2, C3, tuning condenser gang; C4, C8, coupling condensers; C5, C6, C7, I.F. trimmers; C9, C13, C17 (buffer), .05-mf.; C10, 0.5-mf.; C11, 0.25-mf.; C12, 500 mmf.; C14, .002-mf.; C15, .01-mf.; C16, 1. mf.; C18, C19, 8 mf.; C20, C21, 0.1-mf.

Resistor R1, volume control potentiometer, 0.5-meg.; R2, R4, R7, R8, 0.1-meg.; R3, 75,000 ohms; R5, 5,000 ohms; R6, 500 ohms; R9, 0.2-meg.; R10, 50,000 ohms; R11, 0.7-meg.

It is not recommended that any repairs be made to a defective Elkonode (interrupter.) All such units should be returned to the factory (Galvin Mfg. Corp., Chicago, Ill.), or to the manufacturers of the Elkonode (see label on unit).

An open buffer condenser, C17, will be indicated by failure of the rectifier tube V6 to stay ionized. A purple glow in the tube is an indication of correct operation of this type of rectifier; a shorted C17 condenser will be indicated by spasmodic operation of the Elkonode, as well as failure of V6 to glow. As a general rule, when spasmodic operation of the Elkonode is observed it is an indication that the Elkonode is not feeding into the correct load; it either is underloaded or overloaded; two undesirable conditions.

After the Elkonode has been removed, it may be tested by applying 6 volts to the large terminals, with positive polarity to the brown wire; it is also necessary to connect a 5,000-ohm resistor across the red (or green) and black wires, together with an 8 mf. electrolytic condenser and a voltmeter. With this setup, the Elkonode

should consume not more than 2.25 A.; the voltage drop across the 5,000-ohm load should be between 160 and 170 volts, provided the battery voltage is exactly 6.3.

The following precautions should be observed: Do not remove the receiver section of the set from the power pack, with the set turned on; the BR tube, V6, should not be removed from its socket unless the set is turned off. Since the "A" supply is polarized, it is necessary to make certain that the red wire connects to the positive terminal and the white wire to the negative terminal of the battery; do not operate the set with the "A" leads reversed, otherwise the Elkonode will be damaged beyond repair. For this reason, the polarity of the car battery should be double-checked by means of a voltmeter before the set is put into operation. (Reversed connection to the "A" battery will be indicated by low "B" voltage, spasmodic operation of the Elkonode and erratic flashing of V6.)

An ideal place for the reproducer is face-out, with the reproducer flush with the instrument board, but such a position is undesirable because of the space factor. Therefore, the first alternative is to leave it at the same level but to move it back to the bulk-head, for good operation.

If there is not room to mount the reproducer in that position, a second method is to face the reproducer toward the floorboards, with the front-edge of the reproducer against the instrument board and the side against the side of the car, a position available in most cars.

It generally necessitates two holes being drilled through the instrument board to hold the reproducer and an additional bracket run from the adjacent side of the reproducer to the side of the car. This location is rather new to some installation men, but its acoustic properties are superior because of the additional baffle effect which results from the close proximity to the instrument board.

Following is a listing of the preferred location for automotive radio receivers to be used in the 1931 car models specified: Ford, Model A: Motor compartment on the left side;

Chevrolet: Motor compartment on the left side or below the cowl on the right inside; (For 1932 model, remove carburetor and air cleaner, temporarily.);

Buick: Below the cowl on the right inside;

- Chrysler: Right side of car under cowl;
- Pontiac: Left side of motor compartment or right side of car under cowl;
- DeSoto: Ditto;
- Plymouth: Left motor compartment or right side of car, under cowl;
- Cadillac: Ditto;
- Lincoln: Center of motor compartment or right side of car, under cowl;
- Packard: Ditto; (Light Eight, left side of motor compartment.);
- Oakland, V8: Below cowl on right side or right side of car, under cowl;
- Studebaker: Left motor compartment or right side of car, under cowl;
- Oldsmobile: Right motor compartment or right side of car, under cowl;
- Auburn: Right motor compartment or right side of car, under cowl.

(The "bulkhead" is the partition in the car which separates the motor compartment from the driver's compartment.)

Car manufacturers have furnished the following data regarding their provisions, in 1932 models, concerning automotive radio antennas:

- Chrysler: Roof antenna with lead-in and provisions for "B" battery box;
- Dodge: Ditto;
- DeSoto: Ditto;
- Plymouth: Ditto;
- Reo: Equipped with roof antenna and lead-in;
- Rockne: Ditto;
- Studebaker: Ditto;
- Buick: All models, \$6.00 additional for antenna installation;
- Franklin: Roof antenna but no lead-in;
- Ford: Ditto;
- Cunningham: All models, additional charge for antenna installation.

Check the proposed antenna for ground by means of a 0-200 V. meter, 1,000 ohms-per-volt type, and a 200 V. battery. Even on damp days the leakage should not exceed 2 V. Lack of peak resonance on the antenna trimmer indicates a leaky antenna, or one having too great capacity; in general, an antenna screen area of about 9 sq. ft. will be satisfactory.

The dynamic reproducer may be checked for a rubbing voice coil by applying 50 V., 60 cycles, to the two outside or "B" terminals of the output transformer; instead of a clear, steady hum, a rubbing noise will be heard, if the voice coil is not floating entirely clear.

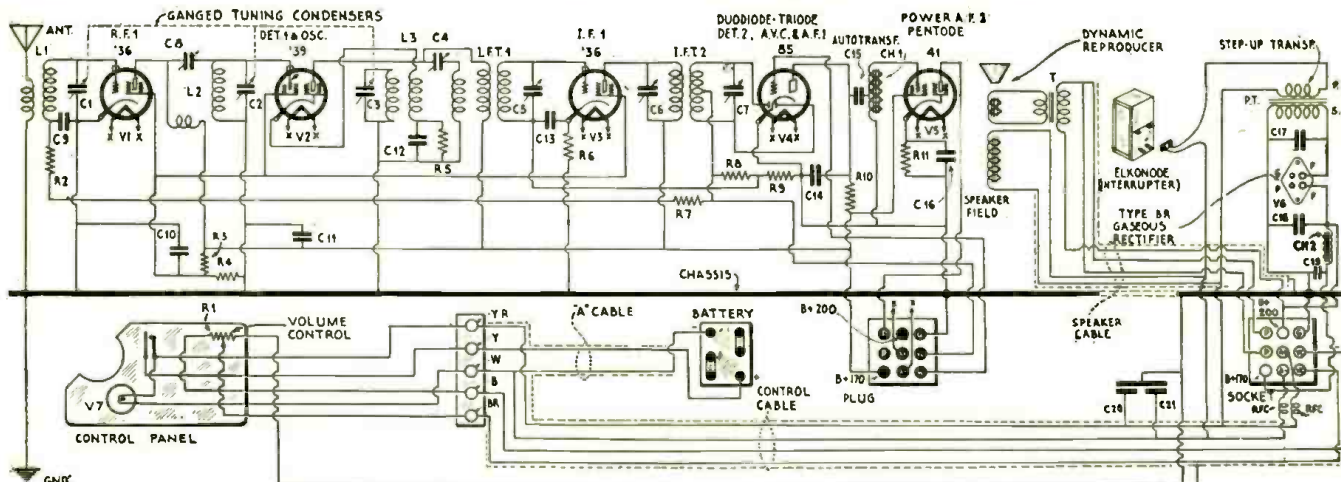

WELLS-GARDNER SERIES 062 AUTOMOTIVE SUPERHETERODYNE

(Incorporating types '36, '37, '38 and '39 tubes; also A.V.C.)

Numerous mail-order houses sponsor this chassis under their particular trade name; consequently, it is better remembered by its circuit connections than by the name of the chassis manufacturer.

In the No. 062 Series automotive receiver the following electrical values are used: Resistor R1, 0.5-meg.; R2, 7,000 ohms; R3, 1 meg.; R4, R13, 0.5-meg.; R5, R12, 0.1-meg.; R6, R7, R8, 2 megs.; R9, 1,000 ohms; R10, 20,000 ohms; R11, 15,000 ohms; R14, 350 ohms; R15, 1,300 ohms.

Condensers C1, C2, C3, equipped with trimmers, constitute the tuning gang; C4 is the oscillator padding condenser; C5, C6, C7, I.F. trimmers; C8, .006-mf.; C9, .02-mf.; C10, C14, 4 mf.; C11, .002-mf.; C12, C18, 65-mf.; C13, C15, C16, 0.1-mf.; C17, .001-mf.

Operating potentials are as follows: Filament potential, all tubes, 6 volts. Plate potential, V1, V3, 177 volts; V2, 173 volts; V4, zero; V5, 54 volts; V6, 159 volts. Screen-grid potential, V1, V3, 80 volts; V2, 76 volts; V4, zero; V5, 77 volts; V6, 165 volts. Control-grid potential, V1, V3, 3 volts; V2, 7 (depending upon dial setting); V4, zero; V5, 6 volts; V6, 15.5 volts. Plate current, normal, V1, V3, 3.6 ma.; V2, 0.9-ma. (depending upon dial setting); V4, zero; V5, 1.2 ma.; V6, 10 ma. All bias voltages must be read from cathode to ground.

Do not check the "A" and "B" potentials at the multi-point socket on the calde head, as the pilot light may be burned out when the switch is turned off. (This is due to the high inductance of the speaker field, which will increase the voltage at the break of the circuit.) Also, when the cable head and multi-point socket are taken off, the connections between the chassis and power

unit are open so that readings are not made under load conditions.

To read the voltages at the sockets the chassis box, in most cases, will have to be removed from its mounting. In some instances, the cables, which may be attached to the dash or at other points, will have to be removed. The voltages can be read at the sockets with a long plug or with a pair of long, insulated test prods.

All tubes must be inserted and all units connected. A signal will effect the control voltages on V1, V3 and V5. If signals are received, ground the antenna and remove V4 to take the other readings.

The diode current establishes a drop across a resistor network; this potential is used as an additional bias potential on V1, V3 and V5, giving A.V.C. action.

The full control potential is applied to V1, two-thirds to V3, and one-third to V5. As the signal increases in intensity, the applied control potential is increased, thus giving uniform output as set by the manual volume control. The manual volume control varies the diode A.F. potential applied to V5.

The tone control is mounted on the dynamic reproducer, which derives its field supply from the storage battery in the car.

Aerials are preferred in the following order: Roof antenna; tape antenna on roof (this is not very effective where a grounded chicken-wire mesh remains inside the roof); plate antenna (strung underneath the running board); under-car antenna (A wire fastened from the right side of the rear axle to the lowest point under the motor, then back to the left rear axle, forming a V. At the vertex of the V is a spring to take up the slack. The lead-in is brought up from the vertex end.).

Do not turn the set on until all the wir-

ing connections of the installation have been completed—this is extremely important.

To adjust the antenna trimmer, tune in a weak signal at the high frequency end of the dial with the manual volume control about three-quarters on. On one end of the chassis box is a small metal plate. Remove the two screws holding this plate. Directly under the hole in the chassis box is the antenna trimmer condenser screw. Adjust this up or down until maximum output is obtained.

Noise, in some instances, may be due to weak pickup caused by a poor antenna. The action of the automatic volume control, due to the low pickup, causes the set to operate at maximum sensitivity, thereby increasing noisy reception, due both to external pickup and internal conditions.

Noisy operation is also caused in some instances by loose parts in the car body or frame. These loose parts rubbing together affect the grounding and cause noises, due to the rubbing or wiping action. Tightening up the frame and body at all points and, in some cases, the use of copper jumpers, will eliminate noise of this nature.

Loose lamps or wiring are also a common cause of noisy operation.

Compensate for the increased battery drain occasioned by the radio set, by increasing the charging rate of the car generator. After a week of car operation, check the condition of the battery and re-adjust the charging rate accordingly.

Two fuses are used on this receiver. The 10 A. "A" fuse is located on the multi-point socket; the 1/8-A. "B" fuse, inside the control unit. The pilot lamp is a standard 6 volt No. 40 unit.

Poor operation may be due to moisture, from car-washings or storms, seeping into undesired places.

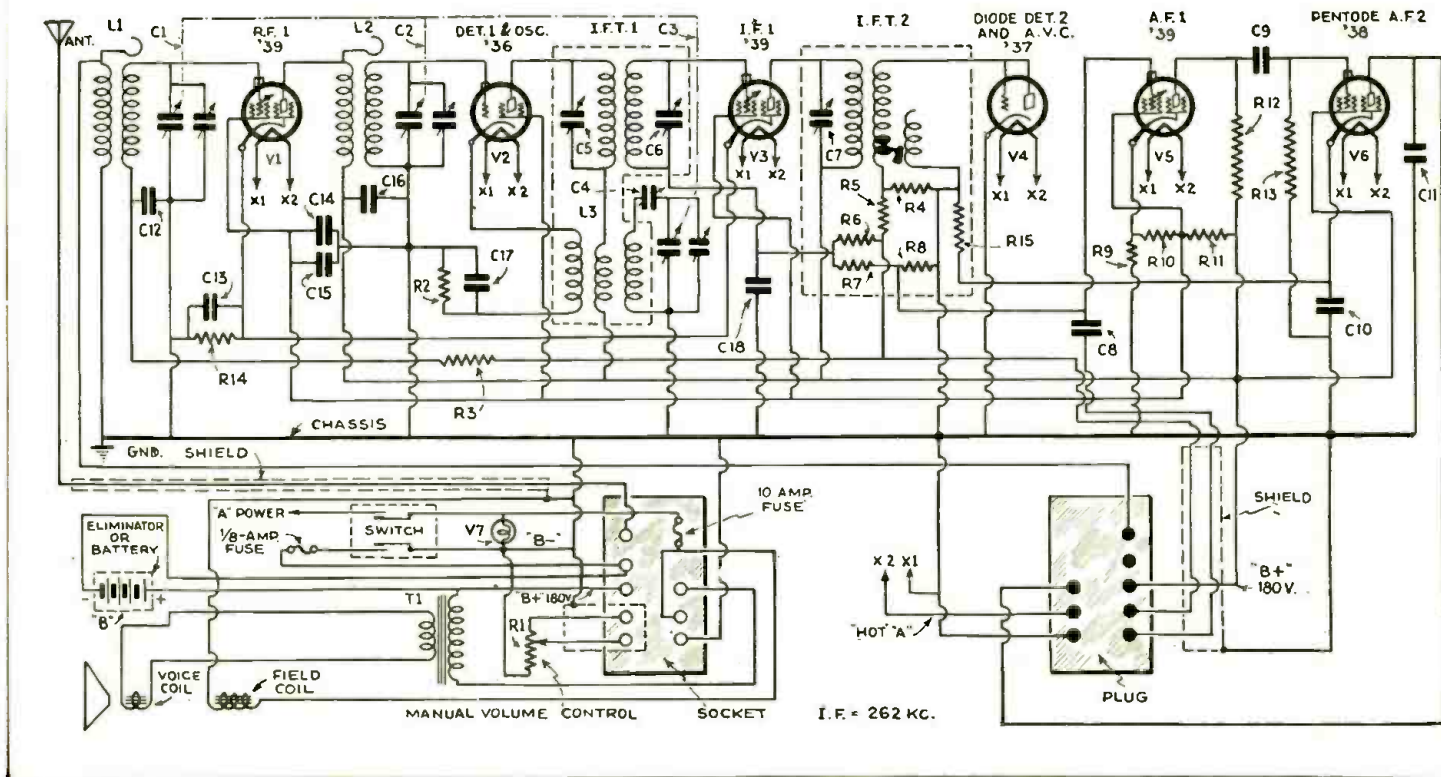

RADIO-CRAFT KINKS

Practical Hints From Experimenters' Private Laboratories

Prize Award

SELF-VULCANIZED RUBBER IN RADIO WORK

By G. L. Garvin

IN Fig. 1 are illustrated several ways in which the experimenter may use self-vulcanizing, tire-repair rubber in his radio work.

A twenty-five cent can contains sufficient material to make about 84 sq. ins. of rubber.

Out of this I am able to make rubber "spaghetti," rubber grommets, test-prod and pliers insulation, and insulating plates of any size.

Glue is not used—the secret lies in tightly pinching the surfaces together with pliers, then cutting along the seam with scissors to make a neat-appearing job. This rubber juncture cannot be separated—the rubber will tear elsewhere first.

REMOTE-RADIO OPERATION

By W. B. Matthews

IN Fig. 2 are shown the circuits of a system which I have set up between my laboratory and my regular household set which is located in another part of the building. The circuit was first designed in order that I might make use of the rather powerful A.F. amplifier with which the set is equipped without either moving the set to the lab., or impairing its value for ordinary use.

By plugging the output of a short-wave tuner, phonograph pickup, microphone transformer, or any other A.F. source into jack A, it may be fed into the detector or A.F. stage of the set. The jack contacts close the circuit from the battery, operating the relay (Rel. 1) which opens the last R.F. secondary winding and applies the input to the grid of the detector. In this way, short-wave programs may be picked up in the lab. and be heard from the regular set speaker. If a plug is inserted into jack B, the relay (Rel. 2) is operated and the output of the set switched back to the lab. to a speaker connected to the plug in jack B. If the plug is removed from jack A the armature of relay (Rel. 1) falls back and the regular broadcast program may be heard from the speaker in the lab. The set can be turned on or off by operating the switch S which controls the power-control relay.

The jacks and the control switch are mounted in a panel along with other jacks and equipment located in the lab. The relays (Rel. 1 and Rel. 2) are mounted in a small box located immediately back of the chassis in the radio cabinet, as is the power control relay.

\$5 for a Practical Radio Kink

As an incentive toward obtaining radio hints and experimental short-cuts, "Radio-Craft" will pay \$5.00 for the best one submitted each month. Checks will be mailed upon publication of the article.

The judges are the editors of "Radio-Craft" and their decisions are final. No unused manuscripts are returned.

Follow these simple rules: Write, or preferably type, on one side of the sheet, giving a clear description of the best radio "kink" you know of. Simple sketches in free-hand are satisfactory, as long as they explain the idea. You can send in as many kinks as you wish. Everyone is eligible for the prize except employees of "Radio-Craft" and their families.

This contest closes on the 15th of every month, by which time all the Kinks must be received for the next month.

Send all contributions to Editor, Kinks Department, c-o "Radio-Craft," 98 Park Place, New York City.

For the connection between the two locations, I use a small cable, but on a long run it may be necessary to use a separate pair for the output of the set in order to prevent capacity feedback into the input pair. Also, it is necessary to keep the capacity between the two sides of the output pair to as low a figure as possible to prevent distortion.

Now for a few notes about the apparatus. All three of the relays must be wound to suit the voltage of the battery supply. If they are properly designed their current consumption can be kept quite low. For the power-control relay, I rewound an old automobile generator relay which I found had large enough contacts to carry the set load. These contacts are connected directly across the regular set switch. For Rel. 1 and Rel. 2 any relays with suitable contact arrangements will do. The contacts of Rel. 1, which are normally closed, are cut into the detector control-grid circuit. Care must be taken to make sure that the input is cut into the grounded end of the R.F. secondary circuit so that the receiver's tuned circuits will not be thrown out of balance. Slightly different arrangements may be necessary for different sets at this point, or it may be wired so as to apply the input to the first A.F. stage. In any case, it is connected the same as a phonograph pickup would be. Any type jacks with an extra pair of contacts may be used as shown in the diagram.

Many interesting uses of this or similar arrangements will suggest themselves to the experimenter.

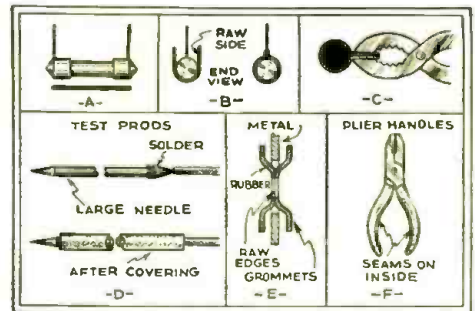

Fig. 1

Here's real efficient insulation.

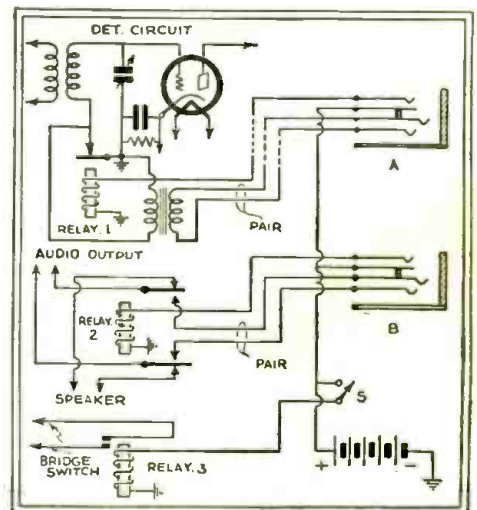

Fig. 2

You can make extra money with this idea.

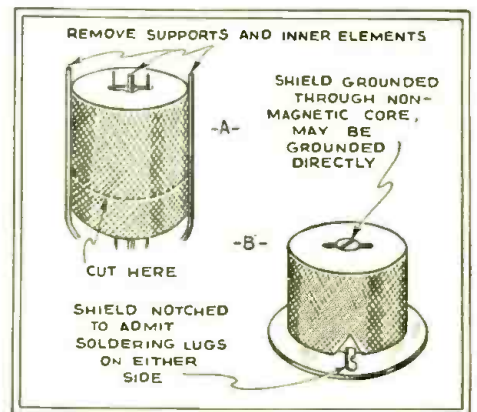

Fig. 3

Shielding R.F. coils—an important thing.

SHIELDING FOR SMALL COILS

By Wm. R. Thames

THE writer has successfully used screen-grids from old '22 and '32 tubes as shield cans for small R.F. choke coils. Perhaps this idea will interest some of the readers of RADIO-CRAFT.

The details of this arrangement are illustrated in Fig. 3, at A and B.

THE RADIO CRAFTSMAN'S PAGE

The Bulletin Board for Our Experimental Readers

"THE RADIO 'TREASURE' FINDER"

Editor, RADIO-CRAFT:

In the June issue of RADIO-CRAFT, on pg. 716, you give the construction details concerning a "treasure" finder. I had one built just the way the article specified, using the parts that were supposed to be used, but the resulting machine will only work a little bit. It seems to me that it is too short-wave. In other words, it will work only when it is settling on metal—*It had to be settling right on the metal.*

What could be the matter with it? I sure would like to get it working as I have spent quite a lot of money on it. If there is anything you can give me light on I sure would appreciate it.

R. L. RIDDLE,
The Kiva,
Santa Rosa, N. M.

(Below is the comment of the author, Mr. Clyde J. Fitch. Note that a slight change in the wiring is necessary to obtain satisfactory results from this practical metal locator; this circuit modification is illustrated in these columns.—*Technical Editor.*)

CONCERNING WHICH MR. FITCH REPLIES

Editor, RADIO-CRAFT:

The treasure finder described in the June 1932 issue of RADIO-CRAFT has aroused so much interest that the editors have literally been swamped with inquiries—and to answer these in a group—this means has been taken so that others, who may be interested, will not be confronted with the same difficulties.

It is unfortunate that almost all who have built the apparatus are disappointed with the results (the letter of Mr. R. L. Riddle is a good example). In many instances we believe this is due to the fact that an error was made in reproducing the diagram of the receiver (Fig. 1 on page 749) and therefore we are publishing the corrected diagram herewith. We were not aware of this error until quite recently and were at a loss to know why so many could not get the apparatus to work.

In the original diagram, the plate supply for tubes V1 and V2 was taken from the plate terminal of V3, instead of the plus "B" lead; this caused the plate current of all three tubes

IMPORTANT NOTICE

In the interest of those readers who do not like to mutilate this magazine, we have asked our advertisers not to place coupons in their advertisements.

Instead of the usual coupons, you will find a number of convenient post cards inserted between the last page and the back cover of this magazine.

This new service will save you time and work. No need to cut coupons, nor is it necessary to hunt for and address envelopes. Moreover, the space for your name on a coupon is usually so small that the advertiser is often not able to make out your writing and then you wonder why you do not get the literature sent for.

Then, last but not least—the postage for a postal card is only 1c whereas a letter now costs 3c.

Read the advertisements and then turn to the page containing the special postal cards. Detach, fill out and mail the card of the advertiser whose literature or offers you want to have sent to you.

Mail your card today! Show the advertisers that you appreciate their cooperation and thoughtfulness.

to pass through the headset. Under this condition the receiver would not work as well as it should. *The corrected diagram published herewith must be followed in building the instrument.*

The apparatus as built by the writer was tested by placing a piece of metal about one foot square near the receiver loop, and while a perfect balance of zero sound could not be obtained by adjusting the angle of the loops, *the presence of the metal could be detected by means of a change in the quality of the sound.* (There

is, of course, a change in volume, but it is very slight and the ear is not very sensitive to slight changes in volume.) The metal sheet could be detected at a distance of four feet from the receiver loop; a typewriter was detected at a distance of six feet.

Some who have used similar apparatus state that it works better outdoors during rainy weather. The reason for this is not definitely known. Perhaps the buried objects, having better electrical contact with moist earth, produce a greater effect. In one case that came to our notice a couple of swords were unearthed; they were about four feet below the surface.

One writer states that he could get a good balance of zero sound indoors, but could get no zero balance outdoors. Perhaps body capacity between his head and the earphones unbalanced the apparatus when his feet were in contact with the ground. Wearing rubbers should prevent this if this is the cause of the trouble.

Check all potentials with an accurate, high-resistance voltmeter. Make certain that grid-leak resistors R1 in Fig. 1 and R in Fig. 4 have the correct values. Try several tubes in their respective positions; this admonition holds true particularly for V1 in Fig. 1—and to nearly the same degree, V3 in the same figure. Try reversing the connections to the primary of the R.F. transformer, R.F.T., in Fig. 1. Test all of the condensers for short-circuit; also, if possible, check them for their rated capacities—or, at least, for open-circuit. Note that unless resistor R in Fig. 4 has the correct value it will not be possible to obtain a satisfactory audio modulation note from the transmitter; in fact, it may not be possible to obtain any audible modulation of this section of the metal-locator.

CLYDE J. FITCH.

MORE TUBES? (!)

Editor, RADIO-CRAFT:

As one who has been interested in radio for many years (I was one of the subscribers to the splendid magazine "Amateur Work" at the time it passed and recall that your own "Modern Electrics" was sent to subscribers to the first-named publication by way of completing the periods for which they had paid their respective subscriptions to "Amateur Work"),

(continued on page 238)

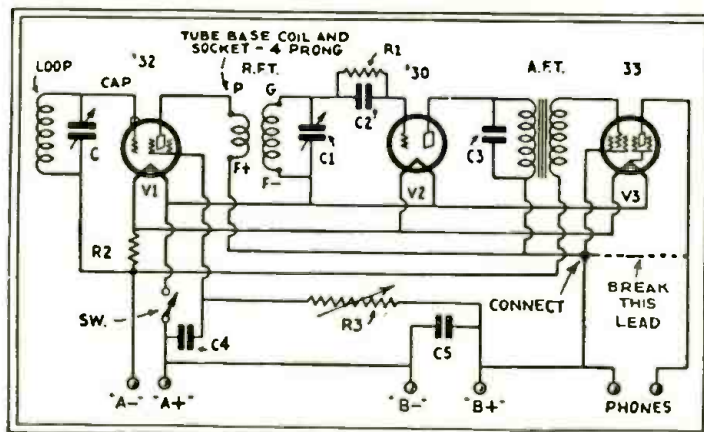

"Treasure" Finder circuit correction.

A PORTABLE LABORATORY

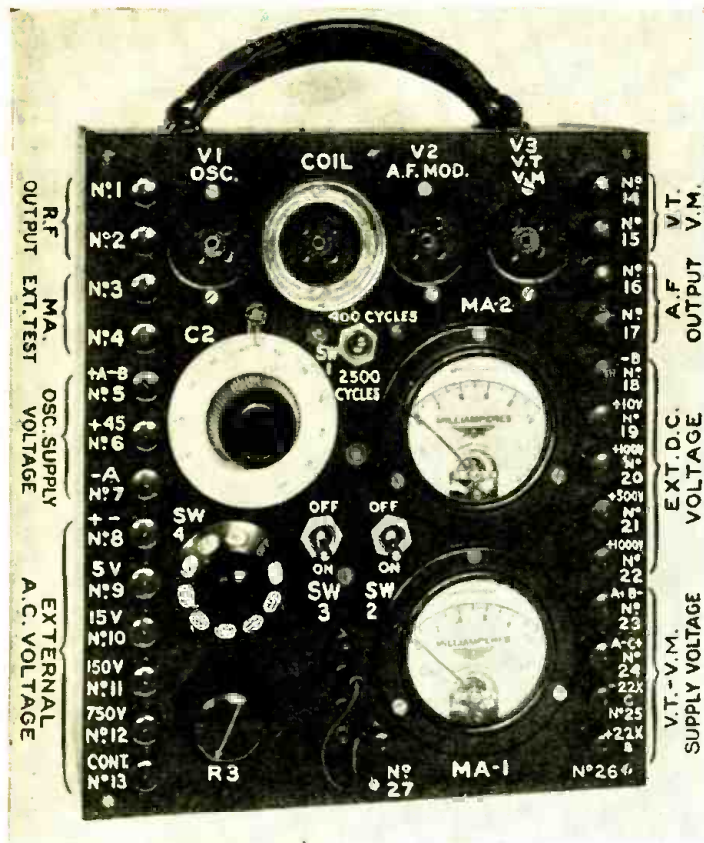

Fig. A
Front view of the very versatile short-wave tester.

● For some unaccountable reason, short-wave receivers do not seem to enjoy the same up-to-date testing that is being given to broadcast receivers. That this may be due, in part, to lack of efficient test equipment seems to be a generally accepted fact. To overcome some of the difficulties involved in testing short-wave apparatus, the author of this interesting article has designed and built the portable testing laboratory described in this article.

This device consists of a vacuum-tube voltmeter; a short-wave oscillator, which may be made to include the broadcast band by the addition of the proper coils; an audio oscillator, which may also modulate the R.F. oscillator if so desired; continuity tester; capacity tester; and may also be used for the measurement of inductance. Aside from the above, the instrument may also be used for an ohmmeter; as an external voltmeter (either A.C. or D.C.) and as a D.C. milliammeter.

The entire unit may be built in a box $9\frac{1}{4} \times 10\frac{1}{4} \times 3\frac{1}{4}$ inches.

SOMEHOW, to a large number of people, the idea of anything connected with the word "laboratory" immediately suggests expensive and delicate apparatus which is far beyond their financial and technical means. There is no basis for this state of mind. Good

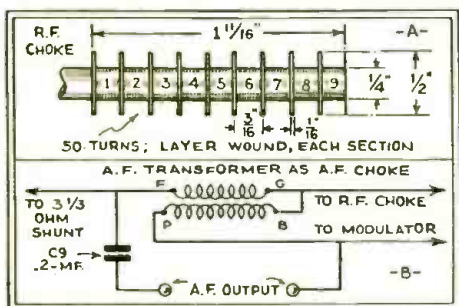

Fig. 2
At A, details of the choke; at B, method of connecting T1.

standards can be built inexpensively, ruggedly, and quite accurately by almost anyone. The ultimate test of an instrument is not always cost, but its practical workability. The simplicity of a circuit, the ease with which it can be built and used, the care with which it must be made are the factors that should be kept in mind when building any piece of equipment.

Expensive parts and "trick" circuits can never equal good workmanship and proven design. The test laboratory to be described in this issue was built to these ideals. It will perform equally as well for anyone, so long as care is taken in construction and adherence to the values given. This unit, Figs. A and B, was built specifically for one of the smaller manufacturers by whom it has been used both in the shop and in the field.

The Variable R.F. Oscillator

Keeping in mind that the oscillator must be as simple and trouble proof as possible, the features emphasized in the design were:

(1) One coil in the oscillator circuit. This would automatically eliminate bothersome feed-back arrangements and simplify the wiring;

(2) The circuit must be absolutely dependable and must oscillate easily, since the maximum available "B" supply is but 45 volts;

(3) Since the oscillator is to be calibrated, the frequency should be spread over the entire dial, as the error in calibrating and reading is less.

The circuit that was finally adopted is a modification of the Colpitt circuit shown in Fig. 1. The stability of this circuit depends upon both the value of the grid-leak R1, and more particularly on the size of the R.F. choke, R.F.C. It was found that with values of R1 varying from 5,000 to 100,000 ohms, the circuit oscillated sharply, but only at certain points. Using a 10,000-ohm leak, the oscillations centered about 4,000 kc.; a 100,000-ohm leak brought the circuit oscillations

down to 2,500 kc.; but the tube refused to oscillate above 5,000 kc. A final value of 2 megohms was selected as giving the best output for the different frequencies.

The same trouble was encountered in the selection of an R.F. choke. While a choke may seem to be excellent at one frequency, it may be very poor at another because of either too large a distributed capacity or, if this is not an objectionable feature, too little inductance. It was necessary to make a choke having high enough inductance at the lowest working frequency and negligible distributed capacity at the highest frequency. The final choke was a nine section layer-wound affair having very low distributed capacity and an inductance of 30 millihenries. This is illustrated in Fig. 2A.

The "band spread" effect was accomplished by having a fixed 60 mmf. condenser, C1, in parallel with the variable 50 mmf. condenser C2. This arrangement necessitates the use of more plug-in coils than are usually needed to cover the desired frequency band. However, the advantage of this method of tuning fully compensates for the labor involved in winding the coils. The economy of the circuit is shown by the fact that not more than 2 ma. is drawn by the plate of the tube at any frequency.

Modulation of the oscillator is accomplished by supplying a pulsating voltage to the plate of the R.F. oscillator tube V1. The plate lead of the R.F. oscillator connects to a tap on the A.F. choke, A.F. 1, in which is present the A.F. current due to the A.F. oscillations generated by the modulator tube V2. The oscillator plate voltage is then modulated by the A.F. voltage drop across the portion "a" of A.F.1. and hence the R.F. output is modulated.

The output of the oscillator is taken through L1, C3 and R2 which form a "dummy" antenna. The output is coupled directly to the receiver under test. Values for L1 and L2 are given in Table I.

The A.F. Oscillator

There is nothing difficult in the building of an oscillator to generate audio frequencies. The requirements are an A.F. transformer, a socket, a few condensers, a grid leak, and an A.F. choke. The transformer T1 has a turns ratio of 3:1; the primary is connected to the grid and filament of the tube. The secondary corresponds to the usual "tickler

SHORT-WAVE

By H. HARRISON

coil" which provides the feed back from the plate to the grid. The precaution here is to reverse the secondary leads if the tube does not oscillate.

The chosen frequencies of 400 and 2,500 cycles are obtained by switching either to a .02- or .005-mf. condenser respectively, by throwing SW1 to position 1 or 2. The A.F. output may be secured separately by connecting leads to the terminals marked "A.F. output." The common coupling choke A.F.1 may be the secondary of a standard input push-pull transformer, or a 6:1 A.F. transformer with the primary and secondary windings connected in series. The connection should then be as shown in Fig. 2B. Switch SW2 controls the A.F. into the R.F. oscillator.

Vacuum Tube Voltmeter

The vacuum-tube voltmeter used in the unit is simple to operate. The input terminals must be connected through a continuous-current-carrying circuit, which may be either a resistor or coil in parallel with the input terminals. If there is no such input circuit, the input terminals should be connected to a resistor of 1. megohm. The plate milliammeter should also be properly adjusted before applying the input voltage to be measured. To make these measurements, it is necessary to connect the terminals under test (assume it to be from the output winding of a transformer) to the input terminals of the V. T. voltmeter. Without operat-

ing the amplifier, that is, so there is no alternating signal, adjust the plate-current reading (MA2) to the smallest readable value. This adjustment is made by varying the potentiometer R3. Note the plate-current reading on the meter (MA1) across the potentiometer. Now start the amplifier so that there is alternating voltage across the output winding. The plate current meter reading is changed. Keeping the signal voltage on, adjust the potentiometer until the original plate current reading is obtained; read the grid voltage. Subtract the original grid voltage reading from the new reading. Their difference is approximately equal to the peak input voltage. Divide this reading by 1.41 or multiply by .707 to obtain the R.M.S. (or effective) value. During the test, SW3 must be closed.

The desired range of voltage measurements may be obtained by selecting the proper tap on switch SW4. Multipliers R4, R5, R6, and R7 have values of 1,000,

(Continued on page 248)

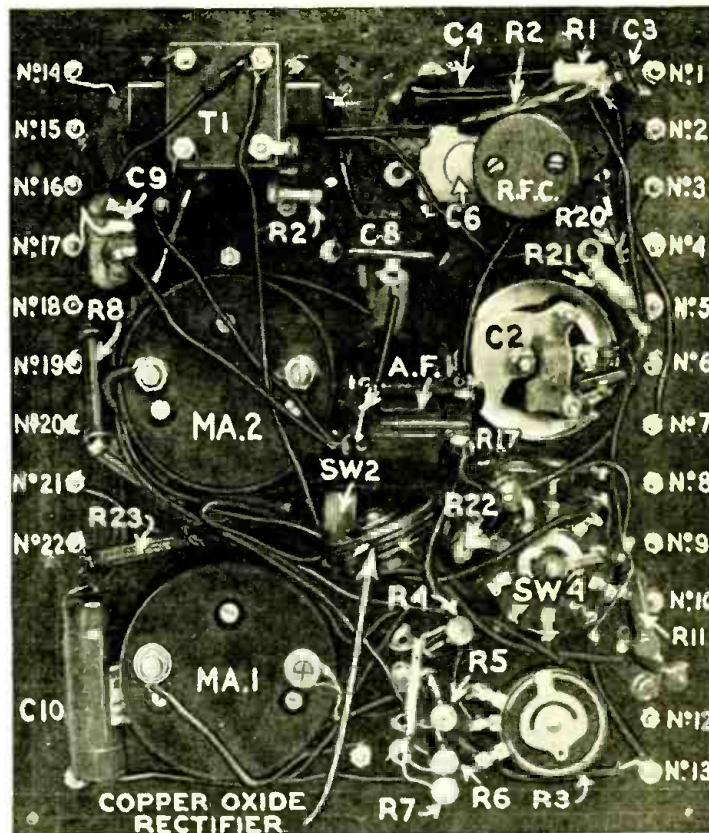

Fig. B

Frequency in kc.	No. of turns of L1	No. of turns of L2	Wire size D.S.C.
1,800	2,680	30	17
2,640	3,250	20	15
3,260	4,160	20	10
4,180	5,380	18	9
5,330	6,460	18	9
6,450	7,160	15	7
7,150	8,200	9	4
8,100	10,000	10	7
10,000	11,800	15	8
11,800	12,800	10	4
12,810	13,480	7	3
15,430	14,820	5	2

NOTE: Coils are not lacquered, are wound on standard III forms, 1-1/8 inches in diameter; L1 and L2 are spaced 1/8 to 1/4 inch. See text for further details.

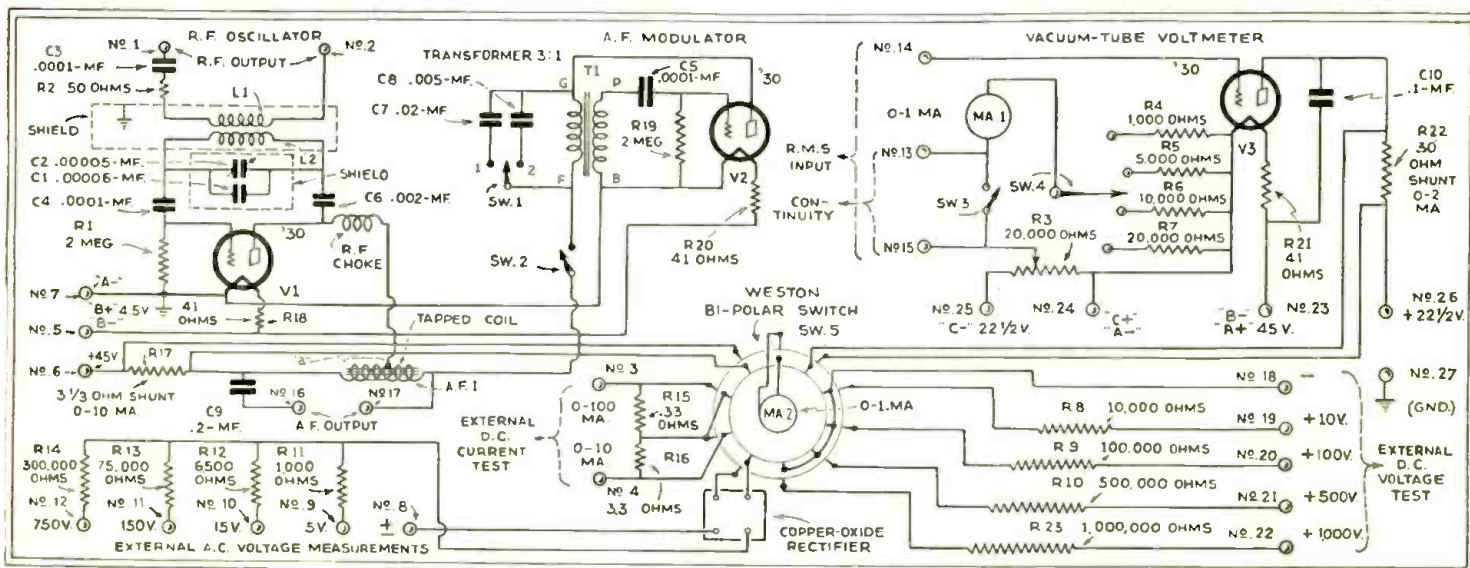

Fig. 1

RADIO-CRAFT'S INFORMATION BUREAU

SPECIAL NOTICE TO CORRESPONDENTS: Ask as many questions as you like, but please observe these rules:

Furnish sufficient information, and draw a careful diagram when needed, to explain your meaning; use only one side of the paper. List each question.

Those questions which are found to represent the greatest general interest will be published here, to the extent that space permits. At least five weeks must elapse between the receipt of a question

and the appearance of its answer here.

Replies, magazines, etc., cannot be sent C. O. D.

Inquiries can be answered by mail only when accompanied by 25 cents (stamps) for each separate question.

Other inquiries should be marked "For Publication," to avoid misunderstanding.

SOUND-CONTROLLED RELAY

(173) Mr. H. Young, Allentown, Pa.

(Q. 1.) Please print the schematic circuit of an amplifier system suitable for operating a relay by whistling or hand clapping.

(A. 1.) By courtesy of Good News we reproduce in Fig. Q. 173 a schematic circuit of this nature.

The following parts were specified in the original layout:

One single-button microphone;

One microphone battery (two large-size flashlight cells);

One microphone transformer with a ratio of 60 to 1, approx.;

One A.F. transformer, ratio 4 to 1, approx.;

Three sockets (two type UY and one type UX);

One power transformer having a 600 volt secondary, center-tapped, one 2.5 volt winding and one 5 volt winding;

Two snap switches;

Two condensers, 2 mf., 400 V., D.C.;

One choke, 30 hy., 40 ma. rating;

One potentiometer, 10,000 ohms, 40 ma. rating;

One potentiometer, 1,000 ohms, 40 ma. rating;

One resistor, 5,000 ohms, 20 watt rating;

One resistor, 4 watts, 1,500 ohms;

One resistor, 4 watts, 1,000 ohms;

One resistor, 4 watts, 200 ohms;

One resistor, center-tapped, 30 ohms;

Two Western Electric, Type B-26 holding relays. (G. E. Type CR-2810-1245A);

One G. E. Master Relay, type CF-2930-1080-C2;

Three Radiotrons (two type '27; one type '80).

The relays are so adjusted that a low intensity of sound will cause one relay to act. This in turn causes a power switch to close.

The second sensitive relay breaks the current through the interlocking power switch and opens the 110 V., A.C. circuit.

Adjust the slider on the 10,000 ohm resistor until the drop across the 5,000 ohm resistor is about 135 volts, then adjust the slider of the 1,000 ohm potentiometer to obtain a bias potential within 4.5 to 22 volts on the control-grid of the second-stage '27. Make provision for reading the plate current of either tube during adjustments. With the microphone out of the circuit, the plate current of the first '27 should be about 5 ma.; the second then should read about 1. ma. The latter value

should increase to about 5 ma. when the microphone is connected into circuit and actuated.

Relay No. 1 is adjusted to close at about 2 ma.; No. 2, at about 4 ma. The latter value is obtained by varying the control-grid bias of the second tube until the plate current is 2 ma.; then 4 ma. After adjustment at the first and then second values, reduce the plate current to 1 ma.

An arrangement of this nature, which will light an illuminated sign at a whistle, and put it out at the clap of hands, is a good money-maker as a novelty attraction.

7-PRONG TUBE SOCKETS

(174) Mrs. L. G. Jensen, Weehawken, N. J.

(Q. 1.) Is there an approved construction design for bases and sockets designed for 7-prong tubes?

(A. 1.) In Fig. Q. 174 are illustrated the base and socket designs approved by the Radio Manufacturers Association. The original illustration was made available by courtesy of Hygrade Sylvania Corp.

MODERNIZING THE FLEWELLING SIMPLIFIED SUPER-REGENERATOR

(175) Mr. John Smith, Chillicothe, Ohio.

(Q. 1.) What would be the circuit arrangement for the old Flewelling "simplified" super-regenerative receiver as redesigned to use the newer types of tubes—for instance, the screen-grid?

(A. 1.) We have not had any practical experience with this interesting circuit modified in the manner suggested. However, we reproduce in Fig. Q. 175 the schematic circuit proposed by Mr. Richard West, writing in a recent issue of the radio section of the *New York Sun*.

A standard 3-circuit tuner, L, is used. The most important portion of the circuit is the grid leak, the value of which must be varied until satisfactory operation is secured with the particular tube used. Note that the .006-mf. fixed condenser must be of mica-insulation type. Coupling transformer T must have a very high-impedance primary. Position 1 of Sw. is the usual connection; position 2, super-regeneration.

We will be interested to hear from experi-

menters who may try out this circuit arrangement.

"MOBILE P. A. SYSTEM"

(176) Mr. R. Costabile, Chicago, Ill.

(Q. 1.) In the August issue of RADIO-CRAFT is described an interesting public address system amplifier consisting of a type '24 tube feeding a pair of '50's in push-pull; a direct-coupled circuit arrangement is used.

Please furnish the following data regarding components of this amplifier: Rating of power transformer; type of resistors used, and; method of connecting more than one reproducer into the circuit.

(A. 1.) The power transformer used in this powerful, high-fidelity public address system amplifier is rated at 200 watts; the high-voltage secondary delivers 750 volts each side of the center-tap. Note the use of separate windings for each of the filaments (this is necessary to obtain correct bias potentials).

The two 0.125-meg. and the two 0.1-meg. resistors are rated at 1 watt; the remaining resistor units are rated at 75 watts (in order to accurately maintain correct values under load).

Additional reproducers will require the use of individual output transformers.

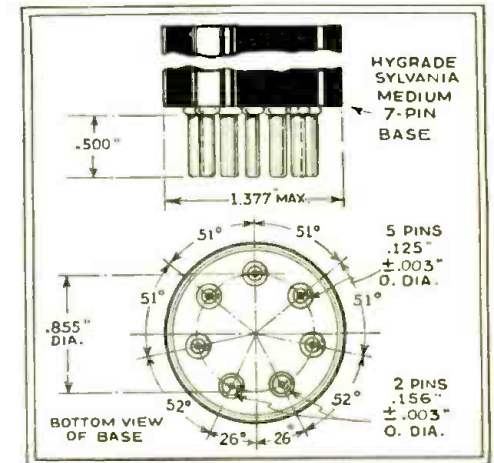

Fig. Q-174. An approved 7-prong socket design.

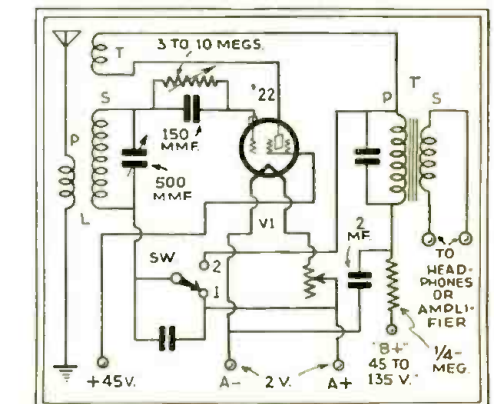

Fig. Q-175. Flewelling "super-regenerative."

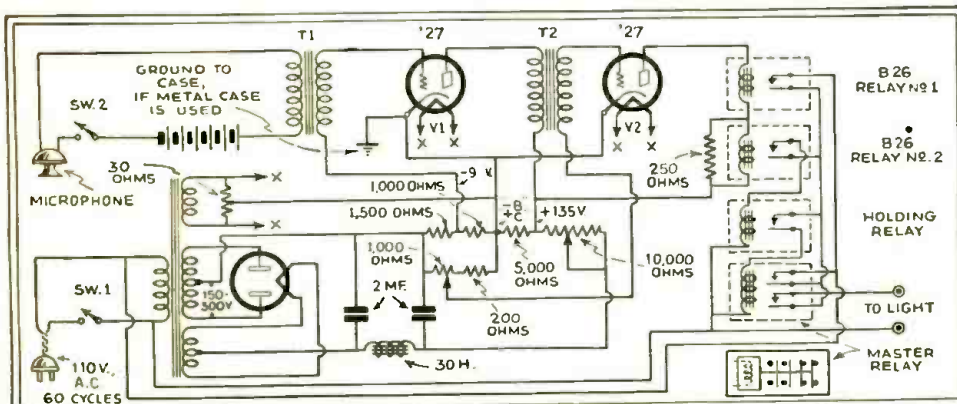

Fig. Q-173. Schematic circuit of a power-control circuit operated by audio sounds.

SERVICING NEW RECEIVERS

By FLOYD FAUSETT*

In order to increase his income, the active radioman must keep himself equipped to render better service to more customers. The radioman who fully appreciates this fundamental factor of profitable radio servicing is interested in testing equipment which will assure less time-per-job for service which is better than the service rendered by his competitors.

Statistics recently compiled by RADIO-CRAFT indicate that only about 9% of the owners of manufactured radio tube socket testers are equipped with manufactured oscillators, and it is probable that most of the oscillators included in this 9% do not provide the necessary frequencies for all the newer superheterodyne radios. It may, then, be conservatively concluded that not more than 9% of the owners of radio analyzers are equipped for performing better service with less time-per-job. Those of the 9% classification ought to complain less about cut-rate competition and let the public know of their better facilities for rendering better service.

Many radiomen rightfully consider themselves as professional men, but professional pride or ethics should not prevent their resorting to other than very modest advertising. For instance, chiropractic doctors believe in advertising their training and clinical facilities, and why should "radio doctors" be less modest? Is there anything wrong with a radioman's advertising that his is the only local service establishment equipped for meter adjustments of all types of superheterodyne radios when his cut-rate competitors are not so equipped?

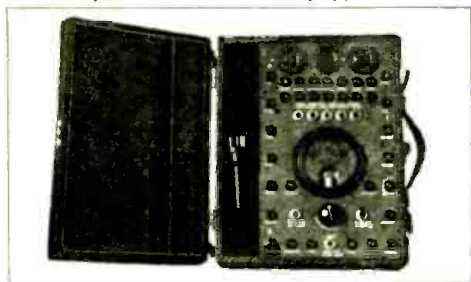

The Supreme 56 Analyzer

The newer types of radios with R.F. pentodes, class A and class B amplification, muting circuits, etc., will introduce service complications which make it necessary that radiomen keep up with the rapid developments of the new radio technique, and keep his equipment up-to-date. In addition to his equipment, he must be interested in the equipment which is designed with the least likelihood of obsolescence. The manufacturers of test equipment are endeavoring to design apparatus which will not become obsolete in a short time. Most of the obsolescence is due to the limitations imposed by the switching arrangements employed. Furthermore, the moving parts of complicated switches constitute a possible source of trouble.

The Supreme Model 56 is an example of an analyzer which eliminates these disadvantages by eliminating the use of rotary and push button switches for connecting the meter to the various circuits. Each range of the meter, and each extended radio circuit has its own set of insulated terminals, and any desired connection can be conveniently made by means of the test leads provided with the analyzer. The cathode circuit, the filament circuit, the top cathode connection of the new 5-pin Wunderlich tube, or any other required circuit may be taken as the reference circuit for voltage measurements.

In the usual analyzer with its complicated switching arrangements, a two-way switch provides the possibility of only two reference circuits: that is, cathode and negative filament. Heretofore, analyzers have provided means for connecting a self-contained 4.5-volt battery into the (1) control grid and (2) the normal grid circuits for tube testing. The latest 6-pin and 7-pin tubes have introduced complications which may require battery connections into

any one of five tube circuits for tube tests. In the Model 56, the battery may be connected into any one of the six grid and plate circuits.

Although the Supreme Models 70 and 60 oscillators were designed before superheterodyne radios became the rule rather than an exception, there has not been a single superheterodyne designed with an intermediate frequency which cannot be accommodated by the original Supreme oscillators which pioneered the harmonic principle of commercial oscillator tuning.

Since many radiomen already have hundreds of dollars invested in testing equipment, they are anxious to have such equipment reconstructed to meet the testing requirements of the new 6-pin and 7-pin tubes and circuits. Arrangements are being made for such remodeling of older Supreme products. In addition, new ohmmeters, volt-ohmmeters, resistance decade boxes, capacitor leakage testers, and meterless tube checkers are being added to the Supreme line. It is believed that the meterless tube checker will meet a long-felt need for a tube checker which can be operated in conjunction with the meters of any good analyzer. This meterless tube checker will incorporate the cathode-heater leakage test and the capacitor leakage test of the AAA-1 Diagonometer, but will be available at a cost much less than that of tube checkers of comparable quality.

Resistance Measurements

The analyses of radio receivers by resistance measurements will, undoubtedly, be recommended in future radio service manuals, and the Supreme products are designed to utilize all of the advantages of these methods as well as affording the usual potential and current measurements during analyses. For service on radio receivers on which resistance data is not published, a decade resistance box has been designed at a low cost. This unit can be connected across an open resistor in a receiver and adjusted for correct potential and current values, when the adjustment of the decade box will indicate the proper resistance value which should be permanently connected in place of the defective resistor. Terminals are provided for measuring the potential across the decade resistors, so that the power requirements of a required resistor can be determined as well as the ohmic value. This box covers the entire range of resistance values found in commercial radios. It is obvious that, with the proper testing apparatus, resistance analyses will greatly simplify and expedite the handling of radio service jobs. It is almost impossible for new radio developments to make ohmmeters and decade boxes obsolete.

Many radiomen who do not already have good testing units are interested in obtaining all of the essential equipment in a single portable unit, such as the AAA-1 Diagonometer with its improvements for accommodating the new 6-pin and 7-pin tubes without adapters. All of the testing functions required in practical radio servicing are incorporated in this unit, including a stabilized oscillator with 100% modulation for covering all intermediate and broadcast frequencies. The oscillator, analyzer, tube checker, and ohmmeter functions of the Diagonometer are separated so that it is practically impossible to harm any of its parts by inadvertent connections.

The ohmmeter ranges extend to 500,000 ohms with a self-contained 4.5-volt battery, and higher ranges are available with external power. The Diagonometer power unit supplies a D.C. potential of 250 volts for leakage tests, etc. Some users of the AAA-1 Diagonometer keep records of overall measurements made on each serviced receiver at several tuning frequencies before and after adjustments, and these records become valuable for making comparisons between receivers. This procedure also enables the radioman to determine the percentage of improvement in sensitivity adjustments in daytime and whether or not a receiver has sufficient sensitivity for distant reception at night. It is believed that such servicing practices with the best of equipment will continue to enable active radiomen to make money because of better service rendered to more customers.

*Chief Engineer, Supreme Instruments Corp.

Look this service over Let I.R.C. Supply All your Resistor Needs

Come to resistor headquarters no matter what your problem. Test for yourself the money-making devices the International Resistance Company provides for Service Men.

METALLIZED Resistors for Replacement



WIRE WOUND RESISTORS FOR METER CONVERSION



HANDY CERTIFIED KITS



Kit No. 1 containing 20 1-Watt Metallized Units
Kit No. 2 containing 20 2-Watt Metallized Units
Grid Bias Kit containing 10 assorted Metallized and Wire Wound units.

Motor Suppressor Kits—for 4, 6 and 8-cylinder cars.

I R C Resistor Replacement Guide

—a loose-leaf manual which gives full resistor data about any popular receiver. An order for 20 Metallized units or Kit No. 1 or No. 2, brings you the Guide FREE. Or it may be bought singly for \$1.

I R C Color Code Chart

In RMA colors—tells instantly the resistance value of any resistor RMA color coded. FREE.

I R C Meter Conversion Charts

They show how to build your own test equipment at astonishingly small cost. Free for the asking.

Make Your Own Set Analyzer

Keep your equipment up to date with the new tubes. A complete instruction folder on the Sprayberry Set Analyzer will be sent without cost.

Feel free to write us at any time. Get on our service list and have the new I.R.C. service helps as soon as issued.

INTERNATIONAL RESISTANCE CO.
PHILADELPHIA, PA. TORONTO, ONT.

I.R.C. Metallized

and Precision Wire Wound

R E S I S T O R S

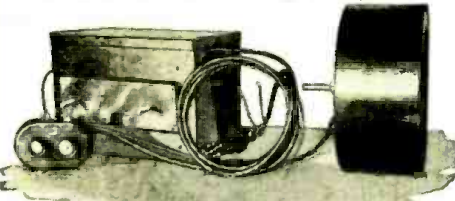
<p>Write Today for Information on This</p>	<p>AUTO-DIAL RADIO Quality, tone, selectivity, and power</p>  <p>COMPLETE \$39.20—includes set, remote control, suppressor kit, tubes and dynamic speaker. Set only \$17.65. Dealers wanted. Write today. J.-M.-P. MANUFACTURING CO., INC. 3358 Fond du Lac Ave., Milwaukee, Wis.</p>	<p>Sensational AUTO RADIO</p>
--	---	--

Mr. SERVICE MAN

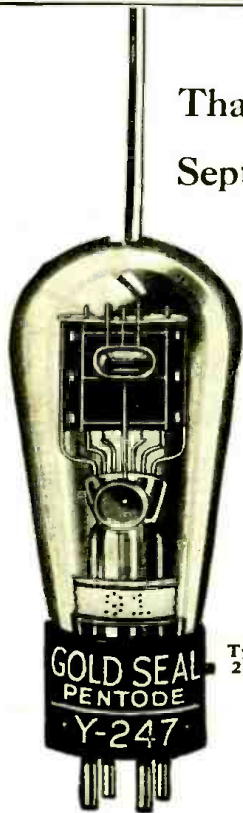

Thank You—Our advertisement in the September issue brought us hundreds of replies, and NOW hundreds of copies of "GOLD SEAL Radio Tube Sales Plans for the Service Man" are on the way. Step to GOLD SEAL Radio Tubes and Profits!

The tubes you need—for receivers, transmitters, public address or television are made by GOLD SEAL.

GOLD SEAL Sales Engineers have developed a special "Selling Plan" for the Service Man. It's yours in return for the coupon.

Newly Made
Fully Guaranteed
Long, Useful Life
Licensed by RCA
And Double Tested
An Experienced Staff
Standard Specifications
Best of Materials Used
New and Modern Equipment

**STEPS TO GOLD SEAL
RADIO TUBES**

Mail Coupon TODAY!

GOLD SEAL MFG. COMPANY
5 Central Ave., East Newark, N. J.

Please send me by return mail Specifications on GOLD SEAL Radio Tubes and your "Sales Plan" for Service Men.

Name _____

Address _____

City _____ State _____

QUASI-OPTICAL HOME EXPERIMENTS

By JOHN B. BRENNAN, JR.

Down below that end of the frequency spectrum where the short waves are to be found, there is a band of frequencies so short in wavelength that they are classed as either light or heat waves and are more correctly termed *quasi-optical frequencies*.

In consequence of the present popularity of experiments and investigations into the realm of television and the transmission of intelligence over short distances by extremely short waves, much attention has been focused on the various and unexplored usages of special types of radio apparatus and equipment such as photoelectric cells, crater lamps, neon tubes, straight-line frequency audio amplifiers, photo-voltaic and other forms of light-sensitive cells, parabolic reflectors, sound-operated light modulators and the whole galaxy of new and unheard of equipment associated with this field of investigation.

To that dyed-in-the-wool and ever growing group of serious minded experimenters who are fast becoming sated with the rebash of present day offerings in the line of radio receiver designs, any new field of endeavor which shows promise of providing an outlet for their pent up energies is eagerly embraced.

It is with the idea in mind of providing such an outlet through the agency of planned home experiments in the quasi-optical field that this department, from this issue of RADIO-CRAFT on, is offered for your serious consideration.

Each month, in this space, one simple experiment will be described and explained in detail, so that those of you who have the time, equipment and inclination may find out for yourselves the marvelous commercial possibilities in the quasi-optical field. The experiments will use only apparatus which can be easily and economically constructed on the kitchen table. As an example of what may be expected the following tentative experiments, to be described completely in later issues of this department are listed and partially described.

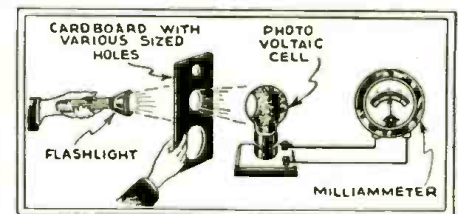

A simple experiment to demonstrate current variations with light intensity.

(1.) Various types of light-sensitive cells and how they work; a simple photoelectric cell and amplifier to demonstrate its ability to change light variations into variations of electrical current.

(2.) A typical photo-electric cell amplifier and how to build it.

(3.) The uses of various kinds of lenses to concentrate, magnify or focus sources of light on photoelectric cells.

(4.) How light may be bent through a quartz tube to actuate a photoelectric cell.

(5.) Forms of light modulators: crater tubes, neon tubes, their uses.

(6.) Mechanical light modulators.

And so the list might go on almost indefinitely. Suffice it to say that the main purpose of this department will be to explain, describe and demonstrate only those experiments which the home experimenter can duplicate at a minimum of expense and labor, to the end that his store of knowledge and experience in this particular field of radio may be enhanced.

As an example of what can be done, the following rather simple experiment is outlined. The parts required for it are: a flashlight, a photo-voltaic cell, a milliammeter (0 to 5 ma.) and some bits of connecting wire.

Connect the two terminals of the photo-voltaic cell to the two terminals of the milliammeter, as shown in the accompanying diagram. It is possible that even the daylight, depending upon the light conditions under

(Continued on page 247)

MODERNIZING THE HI-Q 29

(Continued from page 218)

voltmeter with a scale deflection of at least 500 volts, D.C.; connect the negative lead to clip No. 12 and the positive lead to clip No. 11. A type '80 tube is inserted in the tube socket and the unit is plugged into the A.C. line. The "no load" voltage reading should be approximately 418 volts. Note: Do not leave the power supply unit turned on longer than necessary to make this test.

List of Parts

Five Hammarlund No. ML 17 .00025-mf. Mid-line condensers, C1, C2, C3, C4, C5;
One Hammarlund No. HI-Q 29 coil set, L1, L2, L3, L4, L5, L6;
Three Hammarlund No. RFC 85 radio frequency chokes, L7, L8, L9;
One Sangamo .00025-mf. fixed mica condenser, C6;
One Sangamo .00025-mf. fixed mica condenser, C12;
One Yaxley wire-wound potentiometer 1,500 to 100,000 ohms, R8;
Two Electrad 500-ohm flexible resistors, R1, R2;
Two Thordarson type R-300 audio transformers, AFT1, AFT2;
One Thordarson type R-196 choke coil, AFC;
Six Parvovolt .5-mf. series 200 condensers, C4, C7, C8, C9, C10, C11;
One Parvovolt 2 mf. series 400 filter condenser, C16;
One Parvovolt 2 mf. series 200 filter condenser, C17;
One Parvovolt 4 mf. series 200 filter condenser, C18;
One Parvovolt 3. mf. bypass block, series 200,

C19;
One Parvovolt 1 mf. series 200 filter condenser, C20;
One Durham metallized resistor 2 megohm, R4;
One Yaxley 20-ohm center tapped resistor, R7;
One Yaxley No. 012 cable connector and cable, Y.B.
One RX. Electrad Truvolt III-Q 29 type resistor;
One Thordarson No. R-171 power compact, 1P1;
One* Federated Purchaser filament transformer, catalog No. 2610, FT;
One Parvovolt 4 mf. series 200 bypass condenser, C15;
Two Yaxley No. 422 insulated phone tip jacks, L.S.;
Two Eby engraved binding posts, ANT, GND;
Two Benjamin No. 9040 1X socket, VT.6;
Four* Na-Ald base mounting type UY sockets, VT1, VT2, VT3, VT4;
One* Tru-test 10,000-ohm ½ watt resistor, R3;
One* C midget variable condenser, .0005-mf. U.S.L.;
One* Screen-grid cap connector and wire;
HI-Q 29, master foundation unit containing drilled and engraved panel three complete aluminum shields, Drilled and formed steel chassis, Fahnestock clips, Brackets, clips, wire, screws, nuts, washers, and all necessary hardware to complete this receiver.
One* steel shaft 22 inches long, ¼ inch in diameter.

* Indicates additional parts other than the regular kit of parts necessary to construct this receiver.

NEW TUBES

(Continued from page 205)

cury-vapor type is recommended because it has a low and practically constant space-charge-voltage drop within its operating limitations. As a further means of obtaining good regulation, the filter chokes and transformer windings of the "B" eliminator should have as low resistance as possible. In the design of a power supply for a class B amplifier, consideration should be given to the peak current demand of the amplifier.

As may be expected, the grid (No. 1 and No. 2) of the 89 is operated sufficiently positive to cause grid current to flow in its input circuit. This feature imposes a further requirement on the preceding amplifier stage. It must supply not only the necessary input voltage, but it must be capable of doing so under conditions where appreciable power is taken by the grid of the class B amplifier tube. Since the power necessary to swing the grid positive is partially dependent on the plate load of the class B tube, and since the efficiency of power transfer from the preceding stage is dependent on the transformer design, it is apparent that the design of a class B audio, power amplifier requires that more than ordinary attention be given to the effects produced by the component parts of the circuit. These effects may be produced in the first-stage amplifier by the design factors of the power-output stage. For this reason, the design of a class B audio amplifier with its driver stage is somewhat more involved than for a class A system, and must be checked for each change in the component parts.

The following ratings and characteristics obtain: Heater voltage, 6.3 volts; heater current, .4-ampere; for class A triode operation, plate voltage 160; control-grid bias, -20 volts; plate current, 17 ma.; load resistance for undistorted power output, 7,000 ohms; amplifica-

tion factor, 4.7; plate resistance, 3,000 ohms; mutual conductance, 1,570 micromhos; undistorted power output, 300 milliwatts.

For class A pentode operation, the following characteristics obtain: Plate voltage, 180; screen-grid voltage, 180; control grid bias, -18; plate current, 20 milliamperes; screen-grid current, 3 milliamperes; power output, 1.5 watts; load resistance, 8,000 ohms; amplification factor, 135; plate resistance, 82,500 ohms; mutual conductance, 1,635 micromhos.

Combination Amplifier and Power Rectifier

The first advantage of the unique tube to be described is to provide an electron emitting device having an electron producing area and a plurality of electron emitting cathodes adjacent to this area. Second, to provide a device that can be used in radio circuits and in which the filament or heater current, as well as the plate, can be taken direct from a source of alternating current. Third, and this is a rather unique advantage, to provide a tube having a multi-potential grid, that is, different parts of the same grid to have different potentials with respect to the cathode. Fourth, to provide a self-biasing grid.

The sketch of Fig. 6 illustrates the external view of this rather unique tube. Fig. 7A is a plan view of the internal assembly; 7B is an end view of the assembly shown in Fig. 7A; 7C is a cross section view along the line 4-4 of Fig. 7B; Fig. 7D is a section showing the relative positions of the elements; 7E is a cross section of Fig. 7D along the line 6-6. 8A shows the insulating frame that supports the elements; 8B shows one method of constructing the elements. Two schematic circuits showing the application of this tube are given in Fig. 9A and 9B.

(Continued on page 236)

CORRECTION NOTICE

Due to an error in printing, the cost of constructing the Radio-Craft Universal Analyzer was inadvertently printed as \$28.00. A comprehensive investigation by Radio-Craft indicates that the average price for which the parts may be secured is about \$48.00.

The New Way To Analyze Modern Sets

Point-To-Point Resistance and Capacity Tester

Readrite

No. 1000



\$33 Net

Two cable plugs connect set sockets through selector switch to the precision volt-milliamperere-ohmmeter,—an exclusive Readrite feature. Speeds up tests without removing chassis. Measures resistances up to three megohms — D.C. Volts up to 600 and milliamperes up to 300. Also A.C. line volts and capacity of dry and electrolytic condensers.

A fine instrument in leatherette case. Complete with batteries, test cords and full instructions.

Send for Catalog

READRITE METER WORKS

Established 1904

17 College Ave. Bluffton, Ohio

Our FREE Tube Offer Extended!

So many of our customers have taken advantage of our bonus that we decided to extend this offer . . .

Take advantage of our offer—25 UY-227 Tubes FREE with every purchase of 100 assorted tubes.

(This offer is good until October 7th)

Give to your customers the advantage of buying first-quality licensed R.C.A. tubes at prices that are exceptionally low. We carry the largest variety of tubes in the world, many for special purposes, and every tube is replaceable within three months, providing the filament is not burnt out. We either have the tube you require or we will make it for you.



TYPE O Potassium Photo Cell, 4" overall, \$2.10



TYPE V Television Tube 1 1/2" square cathode, overall size 2"x10", \$3.85



TYPE R Caesium Photo Cell, overall length 3"x16", \$5.90.

COMPLETE STOCK READY FOR IMMEDIATE SHIPMENT
Order from this page—Remit 20% with order, balance C.O.D. All prices are F.O.B. FACTORY, Newark. Shipments go forward express or parcel post. No order for less than \$5.00 accepted.

TYPE	ANY QUANTITY
UX-201A—Amplifier or detector	\$.30
UX-226—AC amplifier	.30
UY-227—AC amplifier or detector	.30
UX-171—Same characteristics as 171A on tungsten filament, 1/2 amp.	.30
UX-171A—Power output amp. for AC or DC operation, 1/2 amp.	.30
UX-230—Designed for impedance and resistance coupling	.40
UX-120—Power amp. used in last stage of audio freq.	.40
UX-199—Detector and amp. tube, long prongs	.40
UV-199—Standard base, has a 201A base, same characteristics as 199	.40
UX-199—Same characteristics as UX-199 only short prongs	.40
UX-112A—Power amp. tube for low cur. consump., 1/4 amp.	.40
UX-112—Power Amp. 1/2 amp.	.40
UX-200A—Detector tube recommended for weak signals	.40
UY-224—AC screen grid amplifier	.40
UX-245—Power amplifier	.40
UX-201B—1/8 Amp. Amplifier and Detector	.60
UY-246—Power Amplifier	.60
UY-247—Power pentode	.60
WD-11—Detector Amp.	.60
WD-12—Detector Amp.	.60
UX-230—Dry cell amp. and detector, 2 volts	.60
UX-231—Dry cell amp.—last audio stage, 2 volts	.60
UX-232—Dry cell screen grid amp., 2 volts	.60
UY-233—Power Amplifier Pentode, 2 volts	.85
UX-234—Screen Grid Pentode R.F. Amplifier	.85
UY-235—Super control screen grid amp.	.85
UY-236—Screen Grid Radio Freq. Amp.	.85
UY-237—Detector Amplifier	.85
UY-238—Power Amplifier Pentode	.85
UY-239—DC R.F. Pentode Amplifier	.85
UY-551—Variable Mu	.60
UY-56—A.F. and R.F. Amplifier and Oscillator	.60
UY-57—6 prong Screen Grid I.F. Amplifier and Detector	.60
UY-58—6 prong Variable Mu R.F. Amplifier and Super Detector	.60
UX-210—For power amplifier, high voltage	1.10
UX-222—Screen grid radio frequency amp.	1.10
UX-250—Power amp. used in last stage of audio freq.	1.10
Balrust tube to prevent tubes in set from blowing out	1.10
Special super-sensitive Audio Freq. 201A	.60
Special super-sensitive Radio Freq. 201A	.60
Special 171 AC 1/2 amp. extra coated filament—good for electric sets	.60
T-14 (201A High Mu) high emission	.60
Switch tube, 201A or 112 or 171 double life	.60
Adapter tube 226, 227, 171A, to convert bat. sets to AC, each	.60
UY-227A—AC amplifier or detector, same as 227 (but qulek heater)	.60
UY-224A—AC screen grid amplifier, same as 224 (but qulek heater)	.60

RECTIFIER AND CHARGER BULBS

125 Mill. rectifying tube (R. H.) (Raytheon Type)	1.25
6/10 amp. triekle charger bulb (Tungar Type)	2.00
2 amp. old and new type charger bulbs (list \$4.00) (Tungar Type)	2.00
5 and 6 amp. charger bulbs (list \$8.00) (Tungar Type)	3.75
15 amp. charger bulbs (Tungar Type)	7.50
Hot Cathode Mercury Vapor Half-Wave Rectifier (Heavy Duty)	2.75
UX-280M—Hot Cathode Mercury Full-Wave Rectifier same as UX588	1.25
UX-281M—Hot Cathode Mercury Vapor Half-Wave Rectifier	1.50
UX-871—Hot Cathode Mercury Vapor Rectifier	1.25
UX-280—Full-Wave Rectifier for High Emission	.40
UX-281—Half-Wave Rectifier	1.10
UX-282—Full-Wave Mercury Vapor Rectifier	1.10

PHOTO CELLS

Photoelectric cell, "Potassium" Type O, 4 1/2" overall length	2.10
Photoelectric cell, "Caesium" Type A, 4 1/2" overall length	7.90
Photoelectric cell, "Caesium" Type R, 3 1/16" overall length	5.90

UX-182—Sparton Type	.85
UX-183—Sparton Type	.85
UY-484—Sparton Type	.85
UX-585—Sparton Type	2.10
UY-686—Sparton Type	.85
UX-401—Kelllogg Type	1.50
UX-403—Kelllogg Type	2.00

Tellon Reflector Neon Television Tube, 1" Cathode Square Type C	3.85
Tellon Neon Television Tube, 1 1/2" Cathode Square Type V	3.85
Tellon Neon Television tube, 1" Cathode Square Type X	2.10

ARCO TUBE COMPANY, 40 Park Place, Newark, N. J.

NEW TUBES

(Continued from page 235)

In Fig. 6 a glass envelope is shown at 1, the upper end of which is provided with a screw type of socket connection having terminals 2 and 3, which connect to filament or heater leads 4 and 5 respectively. These leads serve to support the elements of the tube by being fastened to sleeves 6, the latter forming an integral part of the insulating frame which may be made of lava rock, porcelain or any other suitable material.

The horizontal positions of 7, Fig. 8A, are provided with slots 8 adapted to receive the heater elements, the ends of which terminate into leads 4 and 5. When an equipotential cathode, such as in the '25, '24, etc., is desired, another element, 9, is provided. These cathodes are in the form of plates as illustrated by 10 of Fig. 7B held into longitudinal slots 11 as illustrated in Fig. 8A. The outside faces of these plates are coated with an electron emitting substance.

Part 7 illustrated in Fig. 8A is provided with 4 vertical rows of holes arranged to receive the control grid. This grid may be in the form of a continuous wire arranged in parallel positions close to the cathode. However, where it is desired to place a negative potential on this grid, the grid may consist of a number of thermo-couples each consisting of two dissimilar wires as illustrated in Fig. 7C.

In this figure the positive and negative metals are shown connected alternately and indicated as P and N respectively. Thus, when the central row of junctures (points at which the dissimilar wires connect), *h* in the figure, becomes heated because of radiation by the heater 9, the outer rows of junctures at C of Fig. 7C will remain relatively cool thereby generating a direct current in the grid. Hence, each grid wire will have a potential different from its adjacent wire.

The plates illustrated in Fig. 8B surround the grid structure in the conventional manner. These plates are connected by straps 13 and rest against surface 14 of Fig. 8A.

When the tube is to be used in the circuit which is to rectify the A.C. applied, more than two anodes are required as shown in the schematic circuits of Fig. 9. Likewise, when more than one cathode is desired, the sections may be insulated from one another or separate leads brought out by each cathode. The advantages to be gained are quite obvious. First, this tube may be used in circuits requiring more than one grid, each grid having a different potential with respect to the cathode but all of them having a common input circuit. Second, this device may be used in connection with well-known type of battery coupled A.F. amplifiers in which "C" bias is required. With the device as described here, it can be seen that an internal thermo-electric potential is derived for use in such circuits.

Of special interest to us are the diagrams of Fig. 9. A source of alternating voltage is applied to the heater 9, as well as to the primary winding 15 of a transformer, the secondary 17, of which, has a center tap 18, connected to one lead 19, of the D.C. terminals 19 and 20.

The tube drawn in Fig. 9A has two anodes 12, connected in parallel as shown, which lead into a series of condensers 21 and choke coils 22, before connecting to the points 19 and 20. It may be seen, therefore, that the two outside terminals of the secondary 17 apply voltage to the two inside plates, causing a pulsating D.C. to flow through the filter unit which in turn is applied to the two plates 12 which function in the normal manner. Fig. 9B discloses the somewhat similar full-wave rectifier circuit with the exception that the terminal 20 is derived from a tap between resistors 23 connected in series. The anodes are connected to the outside terminals of the secondary 17 and the cathodes to parts 23.

It would be extremely interesting to note the application to which this tube will be put, for it will evidently become a commercial product. It illustrates, as stated previously, that the trend in modern tube design has been toward a minimum of tubes and an increase insensitivity.

— OR —

Extra Special

with every order for \$5.00 of tubes we will give

FREE 2 UY-227 TUBES

For multiples of \$5.00 proportionate amounts of free tubes will be given.

Be sure to turn to page 256 of this issue and read about the new 1933 OFFICIAL RADIO SERVICE MANUAL which shall be published shortly. Turn NOW to the announcement.

SERVICE MEN! IMPROVE YOUR BUSINESS

BY KEEPING YOUR NAME BEFORE YOUR CUSTOMERS EVERY DAY

FRONT

RADIOMINDER

1	2	3	4	5	6	7	8	9	10
11	12	13	14	15	16	17	18	19	20
21	22	23	24	25	26	27	28	29	30
31	32	33	34	35	36	37	38	39	40
41	42	43	44	45	46	47	48	49	50
51	52	53	54	55	56	57	58	59	60
61	62	63	64	65	66	67	68	69	70
71	72	73	74	75	76	77	78	79	80
81	82	83	84	85	86	87	88	89	90
91	92	93	94	95	96	97	98	99	100

Most people forget the day, the station, the dial number and hour of their favorite programs and will appreciate Radiominder Cards with spaces to record such information. They will be kept for the longest time in any home. Give Radiominder Cards with your ad printed on to your customers or place a few in every home in your neighborhood and they will constantly remind the people of you and thus think and talk about you.

There's No Better Way To Make People Think of You Every Day

These cards are far superior to business cards and their cost insignificant considering the benefits you will derive. Trial orders accepted for as little as

100 Radiominders with your Ad of 5 Lines Printed for **\$1.25** Each additional 100 Cards 50c Postpaid

Card size 3 1/4 x 5 1/2 inches. Ad space 1 x 3 inches. Printed attractively on heavy Golden Rod Bristol Card. Use ink and handprint your copy and mail today with remittance to ROTH PRESS, 825 Sutter Ave., Brooklyn, N. Y.

BACK

1	2	3	4	5	6	7	8	9	10
11	12	13	14	15	16	17	18	19	20
21	22	23	24	25	26	27	28	29	30
31	32	33	34	35	36	37	38	39	40
41	42	43	44	45	46	47	48	49	50
51	52	53	54	55	56	57	58	59	60
61	62	63	64	65	66	67	68	69	70
71	72	73	74	75	76	77	78	79	80
81	82	83	84	85	86	87	88	89	90
91	92	93	94	95	96	97	98	99	100

Your Ad will appear here

AN ULTRA-MODERN SUPER.

(Continued from page 203)

Wiring

The wiring should be done with a good grade of push-back wire and all connections carefully soldered. Wire the filament circuits of all tubes first, twisting these leads together. Then wire the plate-voltage supply, including the rectifier tube, electrolytic condensers, choke, the socket used for connections to the speaker field, and the voice-coil transformer. After this portion of the wiring is finished, complete all plate and plate-return leads to their respective socket and high-voltage supply terminals.

The grid circuits are wired last; and be sure that the connections of this portion of the circuit are as shown in the schematic circuit. Any deviation may prevent the proper operation of the automatic volume control tube. Study this portion of the circuit carefully and follow the connections as shown.

Speaker Selection

As the speaker field is a portion of the filter circuit, it is important that the field have the proper resistance. This circuit has been designed so that considerable variation in the resistance of the field is permissible without upsetting the balance of the various voltages used throughout the set. Do not use a field with a resistance of less than 1,000 ohms or more than 2,500 ohms. The plate voltage on the plates of the I.F. tubes, with a speaker field-resistance of 2,500 ohms, will be just under 200 volts; speaker fields with lower values of resistance will raise this voltage to about 250 volts. If the D.C. resistance of the speaker field is dropped below 1,000 ohms, the filtering action will be impaired and the applied plate voltage will be too high.

The speaker must be provided with an output transformer to match the two pentodes used in the output stage. No provision having been made in the set for placing the output transformer, it must be mounted on the speaker.

Testing and Adjustments

After the set has been completely wired and checked, it is ready for test. Use an oscillator and tune the intermediates to 175 kc. When this has been done, the set can be connected to an antenna, and stations tuned-in.

Adjust the oscillator padding condensers for maximum sensitivity over the broadcast band. Condenser C3A is used to trim the oscillator tuning at the high-frequency end of the tuning scale and C4 trims this circuit at the low-frequency end. Use the slotted plates of the oscillator tuning condenser, C3, for points between the high- and low-frequency settings compensated for by C3A and C4. The care used in tuning the oscillator tuning condenser will reflect in the over-all sensitivity of the receiver.

When the set is properly adjusted, there should be no difficulty in picking up at least 60 channels without any interference from adjacent stations.

Parts List

One Radio Condenser Corp. four-gang tuning units, with trimmers, type 6654, C1, C2, C3, C3A, C5;
Two Micamold condensers, 750 mmf., type 6636, C4A, C13;
One Micamold variable condenser, 5 to 100 mmf., type 2883, C4;
Six Acratrest variable condensers, .0002-mf., type 5358 (these are part of the I.F. transformers), C6, C7, C8, C9, C10, C11;
Six Acratrest tubular condensers, .1-mf., C12, C14, C16, C17, C26;
One Acratrest tubular electrolytic condenser, type 6650, 50 volts, 10 mf., C18;
Two Micamold condensers, 350 mmf., C19, C28;
One Micamold condenser, .006-mf., C20;
Two Acratrest dry electrolytic condensers, type 5308, 8 mf., C21, C22;
One Acratrest bypass condenser, type 2837, .25-mf., C23;
One Micamold condenser, 50 mmf., C24;
Two Flechtheim bypass condensers, type GF-100, —C25, C27;
One Acratrest band-pass tuning unit, as described, type 6654, R.F.T.1 (consisting of L1, L2, and L3);

One R.F. choke, L4 (This may be constructed by winding 700 turns of No. 36 enameled wire on a wooden spool ½-inch in diameter and ½-inch long);

One Acratrest oscillator-detector tuning unit, type 5308, L5, L6, L7;

Three Acratrest I.F. transformers, as described, type 5358, I.F.T.1, I.F.T.2, I.F.T.3 (consisting of coils L8, L9, L10, L11, L12, L13);

One Acratrest 1-watt resistor, 20,000 ohms, R1;

Two Acratrest .5-watt resistors, 400 ohms, R2, R8;

Three Acratrest .5-watt resistors, .5-megohm, type 5860, R3, R7;

One Acratrest .5-watt 6,000-ohm resistor, R4;

One Acratrest .5-watt, 2,000-ohm resistor, R5;

One Acratrest 1-watt resistor, 25,000-ohms, R6;

One Acratrest .5-watt, 500-ohm resistor, R9;

One Frost .5-megohm volume control, R10;

One Acratrest .5-watt, 750-ohm resistor, R11;

One Acratrest .5-watt, 1-meg. resistor, R12;

One Frost .5-megohm potentiometer with switch SW.2, R13;

One Acratrest .5-watt resistor, 200 ohms, R14;

One Acratrest .5-watt resistor, 40,000 ohms, R15;

One Federated cadmium-plated chassis;

One Acratrest power transformer, type 2527, P.T.;

One Acratrest filter choke, 30 hy., CH.1;

One rotary snap switch, SW.1;

One Acratrest push-pull input transformer, type 5834, A.P.T.1;

One Acratrest tuning dial, type 4047;

Four knobs for the controls;

Five screen-grid clips;

Five Acratrest tube shields, type 58;

Five Cinch 6-prong wafer sockets, four marked "58" and one marked "55";

One Cinch 4-prong wafer socket marked "280";

Two Cinch 5-prong wafer sockets marked "47";

One Cinch 5-prong wafer socket marked "56";

One Cinch 5-prong wafer socket, no marking;

One Alden 5-prong plug with short cap, type 5869;

Five feet of lamp cord and plug;

One Eby antenna-ground strip, A. G.;

Four ER type 58 tubes;

Two ER type 47 tubes;

One ER type 80 rectifier;

One ER type 55 Duplex-Diode Triode;

One ER type 56 tube.

A SERVICE LAB.

(Continued from page 219)

may be connected "A," "B" and "C" potentials required to test battery-operated receivers; (the connections from these batteries are brought out to binding posts at the lower left-hand corner of the panel); there is also incorporated a rotary switch for checking the plate voltages at the various terminals of the "B" supply. There are two switches; one is a T.P.D.T. for the filament and "B"; a 5-P.D.T. switch controls the "B" plus potential. When the two switches are in the upward position they control the current to panel No. 8; when they supply the necessary current to Panel No. 10.

Panel No. 10 is an R.F. oscillator which tunes from 550 to 1,500 kc. This panel is also used for the transmission of phonograph records picked up in other parts of the building.

This covers a general description of all the mounted panels.

The portable equipment consists of a shielded oscillator; microphone speech amplifier used in public address work; a standard Jewell oscillator; a G.R. output meter; two Weston 565 tube checker-analyzers. The 565's are used by the outside Service Men.

The two heavy bare copper wires, running parallel underneath the panels, connect to an RCA antenna system on top of the roof. This arrangement enables a set to be connected at any position on the bench.

The steel cabinets are used to house a complete stock of resistors and other accessories for which we are jobbers.

The public address equipment which consists of ten Racon dynamic units with output transformers and trumpets is not shown in the photograph.

Start Your Career Today

In the world's fastest-growing industry—

You can, if you will, start your career today in the world's healthiest and fastest-growing industry—RADIO. The biggest and most talked-of building project in the world—RADIO CITY—is but an advance sign of the future this industry holds for the man who gets started in it today, while the industry is still young. The first move is up to you. Read this advertisement carefully and then send in the attached coupon. But do it now. Get started.



The three volumes of this library cover the entire field of building, repairing and "trouble-shooting" on modern radio receivers. The Library is up-to-the-minute in every respect and is based on the very latest developments in the design and manufacture of equipment. The rapidly-growing interest in short-wave and television reception is thoroughly covered in a complete section which deals with the construction of this type of apparatus.

Radio Construction Library

INCLUDING CONSTRUCTION OF SHORT-WAVE AND TELEVISION RECEIVERS
By JAMES A. MOYER and JOHN F. WOSTREL

Faculty, University Extension, Massachusetts Department of Education

Three Volumes — 1087 Pages, 6x9
605 Illustrations

VOLUME I: presents the fundamental principles of radio so clearly and simply that anyone of average training will be able to read, understand and apply them. It gives actual working drawings and lists of materials for the construction of many typical sets.

VOLUME II: fully discusses all of the elementary principles of radio construction and repair. An explanation of the necessary steps for "trouble-shooting," repairing, servicing and constructing radio sets successfully. Practical data is also given on antenna systems, battery eliminators, loud speakers, chargers, etc. This volume includes complete instructions for the construction and operation of short-wave and television receivers.

VOLUME III: covers the essential principles underlying the operation of vacuum tubes in as non-technical a manner as is consistent with accuracy. It discusses the construction, action, reactivation, testing and use of vacuum tubes; and an interesting section is devoted to remote control of industrial processes; and precision measurements.

EXAMINE these books for 10 days FREE

This Library is not only a thorough home-study course, but a handy means of reference for the more experienced radio experimenter, repair man, and radio shop-owner. To these men, as well as to those who desire to advance in the radio profession, this offer of a 10 days' Free Examination is made.

Simply clip, fill in, and mail this coupon

McGRAW-HILL
FREE EXAMINATION COUPON

McGRAW-HILL BOOK COMPANY, INC.,
330 W. 42nd Street, New York.

Gentlemen:—Send me the new RADIO CONSTRUCTION LIBRARY, all charges prepaid, for 10 days' Free Examination. If satisfactory I will send \$1.50 in 10 days, and \$2.00 a month until \$7.50 has been paid. If not wanted I will return the set at your expense.

Name

Home Address

City and State

Position

Name of Company..... RC-10-32

(WRITE PLAINLY AND FILL IN ALL LINES)

Insure YOUR WORK
with
CLAROSTAT Replacement VOLUME CONTROLS

CLAROSTAT Replacement Volume Controls are "Custom-Made" to exactly suit the receivers for which they are offered. Not a makeshift job lot idea.

The resistance, taper, shape and shaft are made according to the proper specifications.

There is no delay in installing them. There are no comebacks when you use CLAROSTAT products. See the new CLAROSTAT CONTROL HANDBOOK AND CATALOG for 32 pages of dope for service men. Send for your FREE copy.

CLAROSTAT Mfg. Co.
285-287 N. 6TH ST. BKLYN, N.Y.

LYNCH
Noise-Reducing Antenna Products Solve the Interference Problem!

Practically noise-free results on all waves, long and short alike. For the broadcast listener, the short wave and television experimenter and the "amateur." No serviceman should be without these LYNCH Antenna Products which have proved their ability, by test, to eliminate background racket. Ideal for suburbs as well as the most congested city areas. Very simple to "hook-up" to any receiver. Better performance assured.

LYNCH Transposition Blocks
Extremely durable. Made of "Lynchite", a new material, recognized for its great resistance and natural freedom from electrical losses.
Handy Complete Kit of 10 Blocks.....\$2.50

LYNCH Cage-Aerial Spreaders
Great pick-up qualities and freedom from directional effect. Also made of "Lynchite."
Handy Complete Kit of 10.....\$2.50

LYNCH "U. S. Navy Standard" Antenna Insulators
Prevent electrical loss or leakage across the antenna insulators. Kit of 8.....\$3.00

LYNCH Commercial Antenna Insulators
Patterned after the "U. S." but for use where the tensile strength of the "U. S." is not required. Kit of 8.....\$1.50

LYNCH "All-wave" Antenna Coupler
Secures best possible results with any of the noise-reducing antenna systems recommended by us. \$1.50

SERVICEMEN—40% from above List Prices
Send order TODAY or write for new, illustrated and descriptive folder

LYNCH MFG. CO., Inc. 1775-RC B'way., N.Y.C.

Brunswick
Radio Corporation's Exclusive Replacement Parts Service Bureau

Complete stock for all models. Write for free parts list. Service data available.

United Radio Service Co.
Brunswick-Warner Bros. Building
619 West 54th St. New York, N.Y.
Big discount to Dealers and Service Men

Be sure to read the announcement on Page 256 which tells about the 1933 Official Radio Service Manual.

A LAPEL MICROPHONE

(Continued from page 210)

or less current through the microphone, we not only change the volume, but at the same time the pitch and quality of the sound impulses. This is important from the reproducer's viewpoint.

One Man Control

As mentioned in our first article, this lapel microphone can be operated independently from the main controls by having a small control device in the pocket of the speaker. It is thus possible for the speaker, from his own location, to operate the output of the loudspeakers without being compelled to remain near the amplifier unit, thus giving him greater freedom and making a second man unnecessary.

Considering the curves as shown in Figs. 2A and 2B, it will be readily understood that even if a resistor is used as a volume control (and a small variable resistor can be easily placed in a box and carried in one of the pockets), not only can the volume be changed voluntarily by the speaker, but in addition, means are given to him to change the pitch of his voice as may be necessary.

In connection with the electro-acoustical characteristics of this small microphone, it might be well to mention the fact that the quality of sound is also influenced by the direction in which the current passes. It makes a difference whether the current comes from the metal membrane to the carbon grains or the contrary—the resistance changing with the direction in which the current passes.

Taking Sound Curves

These curves have been made by exposing the microphone to the sound of a loudspeaker which was fed with the same amount of current at all frequencies. After the electrical impulses coming from the microphone are amplified by an amplifier of practically linear characteristics between 20 and 10,000 cycles, they are impressed upon a meter.

These curves show clearly that the general transmitting microphone is less sensitive to the general frequency range and almost exclusively pitched to one single frequency which, in our case, is between 2,000 and 3,000 cycles. It may be remarked that curve 1 of Fig. 3 corresponds to a two-button microphone, while curve 2 of the same figure is taken with only one button. All these curves have been actually measured and are independent of any that may have appeared in commercial publications.

The Amplifier

The microphone has polarized prongs so as to make sure that the current flows through the microphone in the right direction. The prongs are plugged in the control-box carried in the pocket and connected from there to the amplifier shown in Figs. 4 and A. As may be seen, a concentrated setup has made possible the placement of the loudspeaker and the all-electric amplifying equipment in one easily transportable carrying case.

The microphone part of the equipment is attached at the upper left corner of the box. This equipment is small and has thus the advantage of easy transportability which means, for instance, that at an election talk, the speaker is able to have his public-address system with him, as if carrying a suit case, and operate it all by himself. Arriving at his place of destination he simply pushes the plugs in at the lower-right of the case and the apparatus is ready for work.

Figure 4 shows a wiring diagram of this amplifier. The rectification of the current takes place in two '81 tubes. The input from the microphone is first amplified by a screen-grid tube which is resistance coupled to one '45 tube. The latter is coupled by a transformer to two power tubes of the 250 type which are wired in push-pull, the output of which is fed over a transformer to the loudspeaker in the case.

Instead of one loudspeaker being attached to the carrying case, this amplifier can be connected to a number of loudspeakers which can be distributed throughout the hall and the

sound of the speaker's voice carried to the farthest corner.

Thus, simple as it seems in its final solution, a vastly improved means has been given to the speaker for amplifying his voice and making his speech clear to every person in the audience.

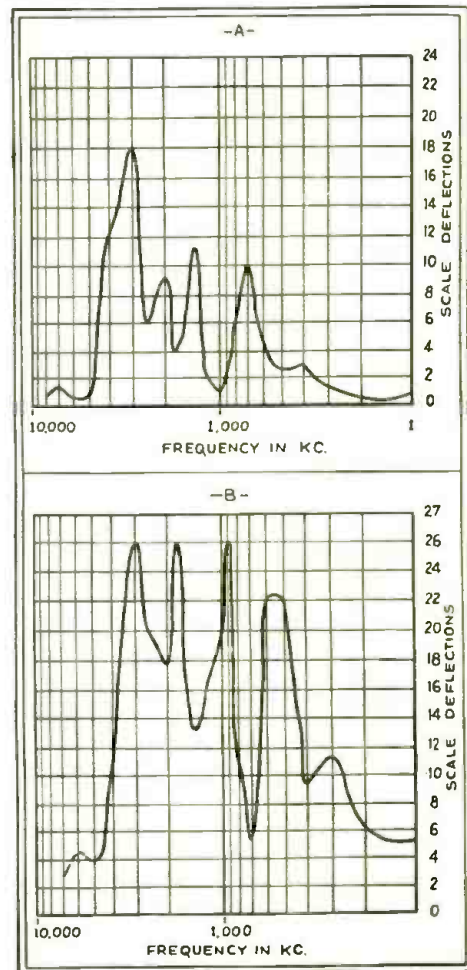

Fig. 2

CRAFTSMAN'S PAGE

(Continued from page 229)

May I submit the following for your comments as well as for the thoughtful consideration of tube manufacturers?

There are on the market today numerous receiving tubes, to be sure; the filament and heater voltages vary from 1½ to 15 and in certain cases even more. In the earlier days of "all electric" receivers a common combination of tubes in a set included a type '27 detector, type '26 in the R.F. and first A.F. stages, and sometimes two '26 tubes in push-pull in the second A.F. stage; (if indeed two stages of transformer-coupled audio frequency amplification did not round out the combination); later on the '71 and '71A tubes came into use in the output stage.

To say, definitely, as to how many sets there are in use, today, that use type '26 tubes, is beside the point; in any event there are thousands upon thousands of them. In addition there are thousands of engineers, experimenters, amateurs and Service Men who use tubes of the '26 type in some circuit or another. The hum feature, of course, has been the drawback to the more universal use of this tube.

With the advent, recently, of the types '56 and '57 indirect-heater tubes, which operate with a heater voltage of 2½ and with a current intensity of only one ampere, a forward stride has been made by our friends the tube manufacturers.

(Continued on page 245)

A. V. C. SYSTEMS

(Continued from page 211)

where a diode detector was followed by four stages of audio (including the output stage), remarked that if the efficiency were to be judged by the number of audio stages, it had to be able to handle a high input.

The manner of operation is simple. Reference to Fig. 5 will show that one side of the tuned secondary coil is connected to the anode; the other side is connected to the cathode through two resistors, the same side of the coil is also bypassed to the cathode which is grounded to the chassis. Since the tube functions as a rectifier, current can flow in only one direction, from the anode to the cathode.

The unrectified half of the wave is bypassed through the small condenser (C1), just mentioned. The rectified half of the wave flows through the two resistors developing a potential across them, which varies with the strength of the signal. One of these resistors (Rc) is bypassed with a fairly large condenser (C2) and its voltage does not vary with the signal modulation. This voltage is used to control the bias on the radio-frequency tubes. The other resistor (R1) has only a small condenser across it (C1) serving as a radio-frequency bypass, and the voltage across it varies with the modulation and is fed to the audio stage. The resistor R2 serves to block radio-frequency currents and keep them out of the audio-frequency end of the channel.

The potentiometer in the grid circuit of the A.F. tube serves the dual purpose of a grid leak and a volume-level control. So far now, we have shown that a constant signal level was maintained but have said little about how great this level was; usually, it is equal to the maximum power that the output stage can handle. Since it is very seldom that such high volume is required, some means of reducing it must be employed. To achieve this end, one of the familiar types of A.F. volume control systems are used. This applies any desired portion of the total output to the output stage, and when it is set for any desired level, it is maintained for all stations. The only exceptions being those too weak to produce the normal output when a state of maximum sensitivity exists.

Another type of volume-level control is shown in Fig. 4, which consists of a variable resistor across the secondary of the input transformer.

The Tuning Meter

The tuning meter shown in Fig. 4 is merely a milliammeter mounted upside down. It is mounted in this manner so that as resonance is approached and the bias applied to the controlled tubes begins to increase, with a consequent reduction of plate current, the needle will swing to the right. Thus, resonance is indicated by the point of maximum deflection. It also gives some indication of the strength of the signal being received, for the more power-

ful the signal, the further to the right the needle will swing, and vice versa.

The meter may be placed in the common cathode lead as shown, or it may be inserted in the "B" common lead of the plate supply. Another location is in either the plate or cathode lead of any one of the controlled tubes. While there is no objection to the use of a moving coil instrument, one of the inexpensive repulsion type instruments is usually used. When a meter of this type is used in the cathode circuit, it will be necessary to reduce the resistance in the cathode circuit, by an amount equal to the resistance of the meter, to prevent the minimum bias from being increased to more than the rated 3 volts due to the extra resistance of the instrument. The meter shown in Fig. 4 requires 15 ma. for a full-scale deflection; if it is desired to be used with only one tube, a meter that will show a full-scale deflection with a current of about 5 ma. should be used.

This should offer an opportunity for the alert Service Man to pick up quite a few dollars. There are thousands of receivers in use that employ automatic-volume-control systems without a tuning meter. Most of the owners of these sets will be glad to have their sets modernized by the addition of this device.

Alignment Procedure

Alignment procedure on receivers using A. V. C. has puzzled a great many Service Men. Obviously, an output meter cannot be used, because if a powerful signal is applied, the A. V. C. keeps it at the same level regardless of ordinary adjustment of the trimmers. It is possible to align a receiver by ear, using a signal too weak to operate the automatic volume control, but this method is notoriously inaccurate. If the receiver is equipped with a tuning meter simply adjust for maximum swing of the needle. If a tuning meter is not used, it will be necessary to insert a milliammeter in the plate circuit of one of the controlled tubes and adjust the compensators until it shows minimum current. In some cases it will be found that one of the trimmers does not affect the meter. This occurs when the control tube is coupled to the plate of the last R. F. tube, and the condenser that does not affect the tuning meter tunes the input to the detector. It will be necessary to use an output meter to accurately adjust this one, or it may be adjusted by ear; in most cases this is sufficiently accurate.

It is hoped that this article will clear up some of the mystery that shrouds the whole subject of automatic volume control, and that some of the readers of this article will feel like tackling the job of building an automatic volume control into their next receiver.

If any points have not been made sufficiently clear I will try to answer any letter in which a stamped, self-addressed envelope is enclosed.

A MODERN REFLEX RECEIVER

(Continued from page 212)

grid terminal is the one isolated from the other four. Looking at the socket from the underside and working clockwise from the grid terminal, the other terminals are cathode, filament, filament, and plate, respectively.

After the wiring is completed and checked, the only adjustments necessary are at the trimmer condensers, 7A and 17A.

The Three-Tube Reflex is amply selective, has enormous volume and has remarkably fine tone quality. It should be used with a high quality dynamic speaker to realize its maximum possibilities.

Top and bottom layout views may be secured merely for the mailing costs—5 cents.

List of Parts

One Cardwell Dual Variable Condenser, .00035-mf. each section, type 217-C, 7, 17;
One Electrad Tapered Potentiometer, type R1-240-P, 12 with switch, 32;
Two Electrad Flexible Grid Resistors, 200 ohms, 3, 11;
One Electrad 1500-ohm Flexible Resistor, type 24 1500, 30;

Two .006-mf. type 1450 Aerovox Mica Condensers, 5, 22;
One Aerovox Mica Condenser, .00015-mf., type 1450, 18;
One Aerovox Metal Case Resistor, .1-mf., type 260, 16;
One Aerovox Duplex Metal Case Resistors, .1-mf. each section, type 260-21, 8, 9;
One Aerovox Metal Case Resistor, .5-mf., type 260, 21;
One Aerovox Dry Electrolytic Condenser, 10 mf. type E-50-10 with mounting ring, 29;
Two Aerovox Dry Electrolytic Condensers, 4 mf., type E5-4 with mounting rings, 25, 25A;
Two Find-all R.F. Coils, 6, 15;
Two Trutest R.F. Chokes, 8 millihenries, type 2110100, 2, 20;
One Trutest Power Supply Transformer, Deluxe Model, type 2C-1512, 31;
Three Trutest 4-prong wafer-type sockets, 28, 33, 26;
Two Trutest 5-prong wafer-type sockets, 4, 23;
One Trutest 6-prong wafer-type socket 10;

(Continued on page 250)

WHAT YOU NEED TO SUCCEED IN RADIO



Courtesy of the National Broadcasting Company

RADIO is a highly specialized business. As it develops it is becoming more exacting in its demands. But radio is the modern field of opportunity for those who keep step with its progress and pioneer in its opportunities!

There is a great need for trained men in the radio industry. There is no place for untrained men. Experience must be accompanied by technical knowledge.

A pioneer in home study, the International Correspondence Schools have kept pace with the times and offer courses prepared by authorities, which give practical instruction in fundamentals and latest developments alike. The courses were prepared and are constantly revised by the Who's Who of Radio!

Composed of 24 basic divisions, the Complete Radio Course is designed to give thorough instruction in the whole field of radio. The I. C. S. Radio Servicing Course was prepared specially for men who wish to become service experts. Study of it makes possible leadership over competition. The I. C. S. Radio Operating Course is vital to mastery of operating and transmitting.

We will be pleased to send you details of any or all of these subjects. Just mark and mail the coupon—the information will be forwarded without delay. Why not do it today—now!

INTERNATIONAL CORRESPONDENCE SCHOOLS

Box 6676, Scranton, Pa.
Without cost or obligation, please tell me all about
the NEW RADIO COURSE

Name _____ Age _____

Street Address _____

City _____ State _____

If you reside in Canada, send this coupon to the International Correspondence Schools Canadian, Ltd., Montreal, Canada

ELECTRICAL ENGINEERING

BOOKS SENT FREE

New Edition Containing 100 Pages

A-C RADIO!

We're glad to send a set to your home to examine and use as your own for 10 days—to show you that here is the most up-to-date and complete work on Electricity ever published. Written by CHICKER of Columbia U.—MILLIKAN of Calif. "Tech."—HARRISON of General Electric and 26 other noted Electrical Engineers. Starts off with elementary Electricity in simple, non-technical language for the beginner and includes every Engineering branch for use of experts on the job.

8 FLEXIBLE MAROON VOLUMES
4300 pages, 3200 illustrations, deluxe gold stamped binding. Index in each book, general Index in Vol. 8. Covers every subject in Electricity—Light, Power, Transmission, Generators, Motors, Switchboards, Radio, Telephone, House Wiring, Railways, etc.

Complete Electrical Reading Course

Electricity, the biggest industry in the world, continues to grow the most rapidly. And it offers better jobs, bigger salaries and a brighter future than any other field. Every dollar, every hour invested in learning Electricity will come back to you a thousand-fold. Learn in spare time with these books at one-fifth the cost of trade courses. Outline for organized study, quiz-questions and a year's free consulting membership in the American Technical Society included without extra cost. If you mail coupon immediately.

LOOK IT UP!
Thousands of these sets are used as REFERENCE books by men employed in electrical, building construction and allied lines. The JIFFY INDEX puts the answers to 20,000 questions right at your finger tips.

AMERICAN TECHNICAL SOCIETY
Dept. E-626
Drexel Ave. & 58th St., Chicago

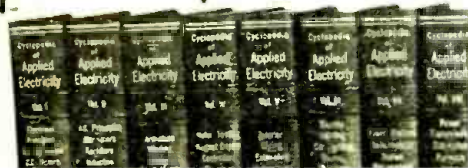

AMERICAN TECHNICAL SOCIETY
Dept. E-626, Drexel Ave. & 58th St., Chicago

Please send for 10 days' free trial volume set of Electrical Engineering just off the press, subject to return if I wish to. (I pay the few cents express charges on receipt of books, you pay express if returned.) If I decide to keep them, I will pay \$2.00 after 10 days trial, then \$3.00 a month until \$34.80, special advertising price, is paid, after which books become my property. Year's Consulting Membership to be included free.

Name

Address

Employed by

Employer's Address

You Can Become a Fast, Capable RADIO OPERATOR at Home

CANDLER Scientific Method

In less than the usual time you can get amazing results. Thousands of fast Radio operators taught by CANDLER. FREE advice if you're "stuck." All questions answered personally. No obligation. If you are now a Radio operator ask about **ADVANCED COURSE for SPEED and Copying Behind**, and "MILL" Course. **FREE BOOK** will save you time and money. Tune in on Candler Short Wave Station!

CANDLER SYSTEM CO., Dept. 47
6343 So. Kedzie Ave. Chicago, Ill.

"Passed amateur exam with 3rd lesson."—E. Miller, Toledo, Ills.
"Studied 11 hours, can copy 8 w.p.m.—E. J. Yarris, Chicago.



World's Only Code Specialist

FREE! The RADOLEK CO

110 Canal Station
Chicago, Ill.

Our new 1932 Radio Serviceman's Wholesale Price Guide will be sent to you upon request. Write, using your letterhead or business card. Send for it today.

TUNING METERS

(Continued from page 214)

glance seems to contradict the statement made previously.

If it is recalled that the fundamental function of any A.V.C. system is to increase the sensitivity of the amplifier for weak signals and decrease it for strong signals, the reason for the connection becomes apparent. (See the article on A.V.C. in this issue.) To decrease the sensitivity of an amplifier, either one of two methods are employed: (1) increase the control-grid bias when variable-mu tubes are used, and (2) lower the screen-grid potential if non-variable-mu tubes are used. Either method of control reduces the plate current flowing in the amplifier stages connected in the A.V.C. circuit as the applied signal increases. This decrease in plate current reduces the reading of the D.C. meter which is connected in the plate circuit of these tubes and furthermore, the greater the signal strength the more the A.V.C. action reduces the plate current and the less the meter reads. This explains why the tuning meter reads full scale with no signal and reads less as the signal increases.

Regardless of the system used, let us suppose for the instant that we are turning the dial of a radio set equipped with a tuning meter. As we approach the extremity of the side band of a carrier, very little action results, but as soon as we receive an appreciable signal (the signal voltage necessary for action varies with different receivers) the current through the tuning meter decreases and therefore the meter reads less. When we reach the peak of the signal, the meter reads a very low value which increases as we pass exact resonance. The lowest reading of the meter represents the best setting of the dial for that particular station. If the meter is connected in the plate circuit of the detector, the best position of the tuning dial is indicated by the greatest reading of the tuning meter as explained above.

Various Forms of Tuning Meters

It is not necessary to have a milliammeter connected in the plate circuit in order to have a tuning meter. The Tune-A-Lite described in the November, 1931 issue of this magazine is an example of a so-called visual tuning meter. This particular device consists of a glass tube filled with neon gas and two electrodes. It is connected in the same manner as a milliammeter would be connected. As the signal increases, the gas ionizes, but in this device the height of the ionized layer varies. This device is used in some commercial receivers and may also be secured separately.

The Tuning Meter as a Trouble Indicator

Aside from the obvious advantages of the tuning meter as an indicating device, it may be used, with a little thought, as a trouble indicator. If the A.V.C. tube of a receiver be removed, the reading of the meter will not change as the strength of the applied signal changes. Thus the reading of the meter is an indication of the condition of the A.V.C. circuit.

A poor tube in the A.V.C. circuit may be determined by tuning-in stations of varying intensity and noting the change in volume. If there is a radical difference in the volume of two loud stations, then the A.V.C. tube is not functioning. However, the method outlined above is far more efficient. If, upon test, the A.V.C. tube is found to be in good condition, but the tuning meter does not function properly, in all probability the resistors in the A.V.C. circuit are defective and should be tested.

Ranges of Tuning Meters

Although tuning meters are simply milliammeters used in a particular manner, nevertheless meters are made especially for this purpose usually having an inverted scale as shown in the photograph. When used in the plate circuit of a power detector, the range of the meter used should be about 5 ma. If the pointer swings off scale, then a shunt is necessary. However, with a 5 ma. scale no shunts will usually be required.

(Continued on page 250)

"The Television Experimenters' Magazine"

NOW 25c A COPY



GREATEST MAGAZINE IN TELEVISION

TIMELY developments in radio's latest wonder, Television, are published in every issue of TELEVISION NEWS—Mr. Hugo Gernsback's latest magazine. Rapid advancement in this art today is becoming a repetition of the radio cycle of years ago. Daily broadcasts are becoming more numerous and experimenters are following in quick order in building television sets for experimental purposes. Foresight of its development can be seen by the pioneers of radio—they are equipping themselves now with television experience.

The articles published in TELEVISION NEWS are of primary importance to experimenters—they are simple in construction, understandable and replete with diagrams, photographs and illustrations.

Interesting Articles in the Current Issue

- Television in Europe.
- Sight and Sound Broadcasting on One Wavelength.
- Visio-Telephony in France.
- Automatic Synchronization.
- Televising the English Derby.
- A Two Way Cathode Ray Tube.
- Controlling Light with Metal Films.
- Television by the Line Control Method.
- Review of High Frequency Receiver Design.
- A Simple Mirror Drum Scanner.
- A Highly Accurate Lens Scanner.
- Pointers on Lens Disc Design.
- A Neat Home Made Telescop.
- An Amateur Television Transmitter.

SPECIAL OFFER COUPON

TELEVISION NEWS 100 Park Place, New York, N. Y. RC-10-32

[] As per your Special Offer, I enclose herewith \$1.25 (Canada and foreign \$1.50) for which enter my subscription to TELEVISION NEWS for One Year. You will also send me FREE the last two issues. I understand that the regular rate for such a subscription is \$2.00.

[] Mail me a sample copy of TELEVISION NEWS for which I enclose 15c (U. S. Stamps or coin accepted).

Name

Address

City..... State.....

INTERESTING LOUDSPEAKER FACTS

(Continued from page 213)

that the amplitude of each resonant position is proportional or equal to the necessary and required values.

Case Design

Much progress has been made in the design of aperiodic cones from which the majority of resonant positions have been eliminated. This is the opposite extreme from that just mentioned; for in this case, all possible things that might possibly cause resonant positions are carefully eliminated. A few years ago it was quite common to hear a distinct and annoying paper rattle in the majority of cone loudspeakers. Analysis showed that the seam in the cone where the cone was glued together was one of the most important reasons why this rattle was prevalent. Therefore an expensive process was developed that pressed the entire cone out of a single piece of material. This immediately eliminated the resonance caused by the seam and almost all cones in speakers today are made in this manner.

It was also found that the kind of material used in the cone itself had a direct bearing on the number of resonant positions. Metals used as diaphragms almost always responded better on the highs than on the lows and therefore resulted in a "tiny" response. Also the amount of resonance was high so that this is undoubtedly the reason why metal cones are not used today. It was found that a comparatively dead substance was the best thing if it could be made into a substance hard enough to use. The research departments of various organizations set to work, and now one of the best cones is that made from ordinary burlap bag material.

It was also found that corrugating the cone had a direct effect on the response characteristic obtainable, and although this is still a question of dispute, it is generally agreed that corrugation does materially aid the tone quality, but the main questions are, where, how much, and what shape? Even the wire used on the voice coil of the dynamic speaker affects the response characteristic. The wire used in this coil is usually wound on the coil form and is of copper. Recently, experiments have been made in which the wire is aluminum and is molded directly on the form. It has been found that a light metal is good but increases the hissing type of background noises. The aluminum just mentioned has been used quite successfully.

The size of the cone used on any type of speaker is of major importance. If we set the reed of a magnetic speaker into vibration without any cone or load connected to it, then it most certainly would be badly underloaded. Due to the small amplitude through which the reed moves there would be practically no air displaced and no sound of any consequence would be heard. If a small cone were applied to the reed, it would still be underloaded and there would be no low frequencies. As the size of the cone is increased, the air displaced will also increase and with it the low frequencies. Now, if an extremely large cone were used, then because the fundamental frequency of the cone is lowered with the increase in the size of the cone, and also because of the inherent inertia of the cone itself, too much energy will be expended in the lower frequencies with the result that the higher frequencies will be overshadowed.

What, then, must we do to obtain a balanced response? The answer is that we must match the acoustic impedance of the cone to that of the reed. This is done in most cases by the law of trial and error. A large cone is used in conjunction with a long reed. A series of response tests are made and then the reed is shortened. More tests are made with different combinations until the law of trial and error has definitely proved to the individual conducting the test just which combination gives the best response.

The amount of energy to be radiated also has a direct bearing on the size of the cone. If we have a condition where only a small room is to be supplied, then a cone of about 14 to 18 inches in diameter will supply a pleasing and natural sound provided, of course, that the motor unit is well designed and the reed

matches the cone. This size cone is well able to handle up to about 12 decibels with good response. For greater power levels the cone should be increased in size to about 22 inches.

In the dynamic type loudspeaker it is not necessary to use such a large cone to get good low-frequency response and the chief reason is that the action of this type of speaker is different than that of the magnetic. In the magnetic the reed supplies the motive power to the cone, whereas in the dynamic the cone is pushed in such a manner as to actually pump air. This feature in itself would not be especially advantageous if it were not for the greater amplitude through which the dynamic speaker moves in comparison to that of the magnetic. The direction of movement of the powerizer in each type of speaker is also different. The reed in the magnetic speaker actuates the cone with a flexing or sweeping movement, Fig. 3. In the dynamic speaker, the voice coil is in a constant magnetic field and the variation in flux caused by the signal in the voice coil produces motor action in accordance with Lenz's Law. The voice coil, therefore, is either sucked into the field or repelled outwards. Thus the cone itself follows the pulsations of the voice coil and the emanating sound is produced through a piston-like action. The amplitude is so great as to produce a much larger amount of displaced air than that which would be obtained with the same size cone in the magnetic type of loudspeaker.

In conjunction with this more efficient method of radiation, the normal and usual impedance of the voice coil is such as to place the speaker in the low impedance category. This means that it is possible to connect the voice coil directly to a transmission line and transmit the necessary energy to the speaker over this line without a worry about crosstalk. If more than one or two lines are used in the same cable or run in the same conduit and operated at similar volume levels.

The principal reason why the dynamic speaker has become so universally prominent and well liked, is undoubtedly due to the low variation in impedance with frequency variation. This would sound as unconnected as the well-known chicken walking across the street because it wanted to get on the other side, yet both reasons are quite correct and exact.

The impedance of the usual magnetic speaker at 1,000 cycles is roughly about 7,500 ohms (Fig. 4). The impedance of this same speaker at 6,000 cycles may be as high, if not higher, than 47,000 ohms! Can you imagine designing a matching transformer or similar device that will also vary its impedance in exactly the same manner as the speaker? In order to produce linear response the matching transformer would have to do just that.

On the other hand, the dynamic speaker has only a very low impedance variation over the frequency spectrum. At 1,000 cycles its impedance is about 14 ohms (Fig. 4), while at 6,000 cycles the impedance rises to approximately 40 ohms—this is certainly different from that of the magnetic speaker. It is fairly easy to design a matching transformer that will operate within these limits. Of course there is the matter of the iron in the speaker being a little different than that of the transformer, but in the dynamic type of speaker the transformer will only mismatch within a few ohms of the actual true value while in the magnetic speaker the transformer may mismatch by several thousand ohms on the high-frequency end. Due to the iron influencing the inductance of the speaker windings and also the inductance of the transformers and thereby, in turn, affecting the impedance, it is seldom that a perfect match is made between the magnetic speaker output matching transformer and the speaker into which it is working. Thus this is one great handicap that is not present with the dynamic speaker.

The Use of Baffles

Let us assume that all the necessary requirements have been complied with and now we desire to install our equipment in various locations. The first thing to consider is the fact that our low-frequency response will de-

Service Men TAKE NOTICE

J. R. Williams, E.E.,* originator and designer of such service instruments as the Supreme Diagonometer, Confidence English Reading Tube Tester, etc., etc., is preparing complete and minute details on the construction and use of all types of service equipment — mostly new inventions. Nothing left out. Measurement drawings and detailed construction.

Within the next few months there will be such releases as Condenser Dielectric Leakage Tester, English Reading Tube Tester, "Resonator," a new method for peaking and aligning, etc.

You get this for \$2.00 a year.

Many months of research and design are behind each release and you will save over \$2.00 on each and every construction.

You will receive detailed construction data on complete large Central Service Station Test Boards. In fact, you will receive one release after another in such complete and concise detail you will be equipped with all necessary knowledge and drawings to build the latest and finest of all radio test equipment.

All of this for \$2.00 a year.

You will know the problems of each device. Nothing to guess about. The first release of an English Reading Tube Tester with all latest tubes is ready for distribution. Way ahead of anything. Next comes a real continuity tester and condenser leakage tester. No guess work as information is complete.

Send your \$2.00 now to

J. R. WILLIAMS AND SONS,
519 Palm Street
Little Rock Arkansas

*Chief Engineer, Apparatus Design Company.

Makes Your Radio **BEHAVE!**

AMPERITE improves radio; protects parts. A money-maker for Service Men. Send \$1.40 to Dept. KC-10 for dealers' sample and sales help.

AMPERITE Corporation
501 BROADWAY, NEW YORK

AMPERITE
Self-Adjusting
LINE VOLTAGE CONTROL

The New POWERIZER MICROMIKE for Public Address Systems and Home Recording

The MICROMIKE is a very sensitive, precision-built microphone, small in size and weight—easily and quickly fastened to the clothing. This MIKE when attached, permits complete freedom of movement and expression.

Simply attached by a thin, flexible, 15 foot twisted cord which is run to a connector. A small "Mikontrol" is connected between the amplifier and the MICROMIKE—it can be hidden in the pocket and controlled by hand.

The MICROMIKE is quickly adopted by educators, public speakers and entertainers. It is not a toy microphone, but is extremely practical. It has a stretched alloy diaphragm, and is gold-plated—finished in opal silver. Constructed to meet rigid tests. Furnished with fastening clip. Combined with the "Powerizer," the MICROMIKE makes an ideal portable outfit.

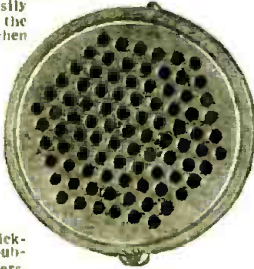

Front View

PORTABLE PUBLIC ADDRESS SYSTEM
with Portable Powerizer P-32, complete with Micromike Mikontrol and all tubes \$96.00
Micromike, \$12.50 Mikontrol \$3.50

MICROMIKE and MIKONTROL sent prepaid to any part of U.S.A. upon receipt of price. POWERIZER Portable Address System shipped anywhere in this country upon receipt of \$10.00 deposit, balance C.O.D. Guaranteed for 90 days.

Send for our bulletins covering portable and permanent public address and central radio systems.

RADIO RECEPTOR CO., Inc.

106 Seventh Ave.

New York, N. Y.

FREE Amateur and Servicemen's Wholesale Guide

Hot off the press! Chock full of the latest of everything for the Radio Serviceman, Amateur, Experimenter. Detailed illustrations; vital and interesting facts. Valuable tips that mean money in your pocket.

Astonishing Low Wholesale Prices
Hundreds of "Hot Shot" bargains at deep cut prices that challenge all America.
WRITE TODAY—A free copy of this record smashing book is ready for you. Write for it today!

BURSTEIN-APPLEBEE COMPANY
1408D McGee St., Kansas City, Missouri



1933 Edition
UNIVERSAL
CATALOG

Keep posted on the new Universal products. Get your copy from your dealer.

New items include the superfine line of Bullet Type Microphones; the new compact Torpedo Microphones; the Watch Model "W"; the super-sensitive Midset Model "M"; the sensational 2-button, popular priced "X"; and an ultra-modern line of Transformers that will set the pace for years to come.

Universal Makes Tomorrow's New Developments Available Today!

UNIVERSAL MICROPHONE CO., Ltd.
424 Warren Lane, Inglewood, Calif., U.S.A.

Back issues of RADIO-CRAFT can be had at the regular price of 25c each. Mail remittance to RADIO-CRAFT, 98 Park Pl., New York, N.Y.

AERO SHORT WAVE RECEIVER..... \$ 6.45
AERO AUTO RADIO, Complete..... 39.50
AERO SHORT WAVE CONVERTER..... 12.50

Send for Complete Catalog

CHARLES HOODWIN CO.
Dept. X-15
4240 Lincoln Ave. Chicago, Ill.

pend directly on the size of the baffle that must be used in conjunction with our loudspeakers. Perhaps one wonders just why a baffle is so necessary in order to obtain good low-frequency response.

Baffling is by no means a new idea, for as early as 1868, Lord Rayleigh, one of the most proficient of the old masters, showed, in an extremely interesting experiment, that by preventing the air on one side of a tuning fork from circulating with that of the other side, the intensity of the sound from the tuning fork could be tremendously increased. Consider Fig. 5. As the tuning fork moves towards "B," the pressure of the air in this direction will be increased. At the same time the pressure at "A" will be decreased due to the displacement of the tuning fork in the direction of "B." Thus there will be created a difference of pressure between "A" and "B" and the air of the higher pressure will move to that of the lower, or the air at "B" will move to "A." Now this movement of air from "A" to "B" is spoken of as the "Lateral Motion of the Air."

Lord Rayleigh found that by placing a piece of cardboard in such a position so as to prevent the lateral motion of the air, the sound from the tuning fork was greatly increased. Lord Rayleigh, however, was not alone in his experiments for, as a matter of fact, most of his work was based on the results of the experiments of the late Professor Stokes. To indicate the importance of the elimination of the lateral motion, Professor Stokes estimated that in connection with middle "C" of the piano, it would be possible to increase the output 40,000 times by the complete elimination of the lateral motion of the air, thereby causing the air in front of the unaided string to travel in a thin strip.

The above however does not explain why it is necessary to have a baffle for good low frequency response. However, it is the prevention of the lateral motion of the air that brings in those deep lows that are so hard to obtain.

Referring to Fig. 6 in which is shown the radiation curves of the various frequencies, viz: high, medium and low. It will be noticed that the very high frequencies are projected in the form of a beam while, as the frequency is decreased, the angle of radiation becomes larger until at the very low frequencies the waves literally "creep around the cone." Now the cone is similar to the tuning fork shown in Fig. 5 in that it vibrates between two points. If a signal of any frequency is generated by the cone, it will move first in a direction towards "B." The pressure at "B" will be increased while that at "A" will be decreased. Sound travels at 1,100 feet per second. The wave generated by the movement towards "B" will therefore travel at 1,100 feet per second in either a beam, a short angle or else will move around the face of the cone depending on whether the frequency is high, low or medium.

At the same instant that this pressure wave is created, the cone also creates a wave on its other side which is in exact opposite phase to that of the first wave. If the generated frequency is high, then it will be projected in a beam and the positive and negative half waves will not meet. As the frequency is decreased the waves will be radiated in accordance with Fig. 6 so that on the lower frequencies the positive wave will have time to get around to the back of the cone and cancel the wave toward "A." When this happens, of course, we hear nothing and this is exactly what happens when we do not use a baffle.

Likewise, it is evident that the effect of the baffle is limited to the lower frequencies; for on the higher frequencies the radiation is in an opposite direction to that of the negative wave due to the beam effect at these frequencies.

SUGGESTIONS

The problem of what to charge for service calls is as great today as ever. RADIO-CRAFT would like to hear from various Service Men who have tried different methods of charging the customer and found them to be successful. Remember, only those who have real information to offer should reply.



Send stamps for charts showing adapters to use with different makes of testing equipment for testing all the new tubes, including 55-85-57-58-82-G-2-41-421 Wunderlich and the new seven prong tubes.

ALDEN MFG. COMPANY
BROCKTON Dept. R. MASS.

DRUM DIAL CABLES

42 strand genuine phosphor bronze
SPECIAL LOW PRICE

We stock at all times or will make for you ANY DRUM DIAL CABLE
FOR 8 CENTS EACH

DRUM DIAL CABLE WIRE

Twisted.....1½ cents per foot
Braided.....1 cent per foot

Send for samples and
catalog sheets

PEERLESS RADIO PARTS CO.
Box 264
Wilkes Barre Pennsylvania

S. GERNSBACK'S RADIO ENCYCLOPEDIA

What the New Second Edition Radio Encyclopedia Gives You

It gives you an explanation of every word used in radio.

2,201 RADIO DEFINITIONS
1,253 TECHNICAL ILLUSTRATIONS
34 TABLES AND CHARTS
24 PAGES OF APPENDIX
Red Morocco-Keratol Flexible Binding
Printed on strong ledger paper, Loose-Leaf Arrangement

352
pages
9 x 12
inches
Weight
3
lbs.

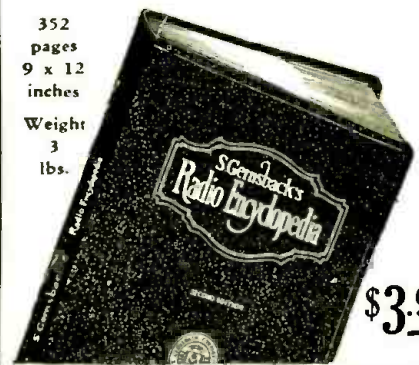

S. GERNSBACK CORPORATION,
98 Park Place, New York, N. Y.

Send me one copy of the new Second Edition S. Gernsback's Radio Encyclopedia. I enclose herewith \$3.98, check or money order preferred. (Foreign and Canada, add 35c extra for postage.) Money refunded in full if not satisfactory.

Name

Address

City..... State.....

RC-10-32

A. F. CHOKE DESIGN

(Continued from page 215)

ductance of a transformer or choke. The factor $u_{a.c.}$ is defined as being equal to $\Delta B/\Delta H$ or the increment in B divided by the corresponding increment in H for a given A.C. flux. It may be readily seen that the value for $u_{a.c.}$ is something quite different from the arithmetical value for u obtained from the original B/H curve. This value is not really a constant as it varies over a range of A.C. flux densities. The relation of $u_{a.c.}$ to the A.C. flux is shown in Fig. 1D for two values of D.C. magnetizing force. These values are for a particular core material and are consequently not for design purposes.

With $u_{a.c.}$ determined for a given D.C. flux density the inductance of the winding may be calculated from the equation.

$$L = \frac{4 \pi A N^2 u_{a.c.}}{10 \times 1}$$

It will be noted in Fig. 1D that the value $u_{a.c.}$ increases slightly for the higher values of A.C. flux density but the increase has the effect of slightly adding to the inductance of the winding and is therefore beneficial in its effect except where sharply tuned circuits are involved.

If an air-gap be provided in a magnetic core the D.C. flux density will fall off but an increase in the A.C. permeability will obtain. There is an optimum value for this relation which depends upon the characteristics of the particular iron chosen for the core material. That is to say: for some length of air-gap,—for some substitution of a material having unit permeability for a portion of the magnetic path the A.C. permeability will be at a maximum. Not only this, but the D.C. flux density may be varied over a wide range with but slight effect upon the inductance of the winding.

In most A.F. transformers a certain percentage of air-gap is necessary (although it is provided in the case of the highest quality transformers only). The air-gap may be dispensed with only when the D.C. flux density is at zero through the use of parallel feed systems. In push-pull transformers the D.C. components are assumed to cancel but there are high values of A.C. in the core and a certain amount of D.C. is always present due to tube irregularities so that an air-gap is still essential to an economical design.

In order to offer a series of chokes for the average experimenter to construct with a full knowledge of the characteristics that will obtain it is first necessary that a particular lamination be chosen which will be available to him. A core form which will offer a range

in the neighborhood of 30 henries for all normal values of D.C. flux and which will at the same time lend itself to an economical design in so far as D.C. resistance is concerned may be achieved around the EI-11 lamination of the Lamination Stamping Company (located at Brackenridge, Pa.)

The dimensions of this core are as shown in Fig. 2. The characteristics of a core having a square cross-section are as follows:

- Window area, .575-sq.-in.;
- Volume, 4.05 cu. in.;
- Core weight, 1.13 lbs.;
- Area, 4.94 sq. cm. or .766-sq. in.;
- Length of path, 15.61 cm. or 6.13 in.

Winding data from the charts is based on the use of enamel wire of the size indicated and with glassine paper between layers. The ends of windings should be straightened with pieces of fiber and the core itself should be protected with several layers of brown paper.

In forming the windings a piece of wood should be cut to slightly less than the core dimensions and wrapped with one layer of string. After winding, this string may be pulled out and the coil removed from the wood form. The values for the air-gap given in the chart refer to the total gap and in the case of EI laminations the gap at the center and in each leg should be just half the value read from the chart. Any machinist will lend you a micrometer to assist in building up wafers of paper or of fiber to insert in the legs. The holes provided in the core offer ready means for mounting and for clamping in position by means of iron or brass straps in methods which will readily suggest themselves to the experimenter.

Variations from the data in the charts may be achieved by varying the "stack" of the laminations. For double the stack (2 x .875-in.) the inductance will be doubled for a given current density and number of turns; while the resistance of the windings will be increased by but one-third. For one-half the stack specified, the inductance will be halved; and the resistance will be reduced by about 16 percent.

We may thus achieve with this single type of lamination any value of inductance up to 60 by with D.C.; or up to over 200 henries where no D.C. is employed. The core material employed in calculating the charts was Allegheny Super Dynamo Grade Steel Sheets and the calculations are based on the assumption that 1 volt of A.C. is superimposed on the D.C.; for high A.C. flux densities a slightly higher inductance will prevail.

As an example, let us suppose that we desire a choke having an inductance of 20 henries at a current of 120 ma. on the core specified. Tracing through from the 20 henry line at the left edge of the curve we find that this cuts the 120 ma. line at 6,700 turns. We find from the wire size—resistance curve, that the wire size for this number of turns is No. 35 enamel; and that the resistance of the choke will be 1,100 ohms. Under these conditions the second chart shows that the air-gap is about .045-in. This means that .0225-in. of insulating material will be required in each leg of the choke core.

Now, an efficient choke should not have a resistance so high as this unless designed for a specific purpose—for instance, let us suppose that a receiver employing a 2,500-ohm dynamic field in its filter system must be used with an external speaker and we desire to replace the original speaker field with a choke. In this case we would work backwards from the specifications that our choke must have a 2,500-ohm resistance. On the basis of economy, let us see what we can do with our choke design in order to reduce the resistance.

As we noted before, increasing the height of the core stack by 100% increases the inductance of any form of winding by a like degree. On the basis of a square stack we start with an inductance of 10 henries at 120 ma. This calls for 5,000 turns of No. 35 wire, a total resistance of 450 ohms. Increasing the stack by 100% likewise increased the resistance by one-third. Our total resistance is therefore 600 ohms. Reference to the second chart indicates a total air-gap of .035 in. or .0175-in. in each leg.

Order a set of the NEW CENTRALAB Motor Radio Suppressors Today!

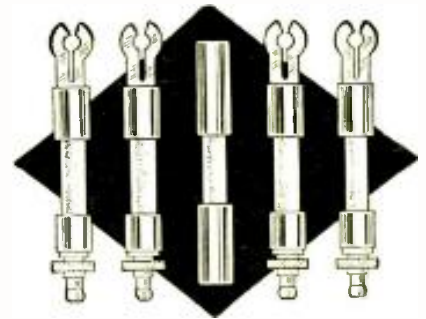

for the NEW Centralab Suppressors are actually 50% to 500% more efficient in reducing spark noise than the average suppressor.

The generous 1/2" of resistance material is baked at a temperature of 2700 degrees with its ceramic jacket; both together forming a solid granite-like unit. Simplicity itself!

And this very simplicity makes possible an unusually LOW price. Order a set today . . . one for each spark plug plus one for the distributor.

	Retail Price	Your Price
Set of 5 for 4 cylinder car	\$2.00	\$1.10 net
Set of 7 for 6 cylinder car	2.75	1.50 net
Set of 9 for 8 cylinder car	3.50	1.90 net

Centralab

CENTRAL RADIO LABORATORIES

930 E. Keefe Ave. Milwaukee, Wis.

\$5,000 WILL BE PAID TO ANYONE WHO PROVES THAT THIS IS NOT the actual photo of myself showing my superb physique and how the Ross System has increased my own height to 6 ft. 3 3/4 inches. Hundreds of Testimonials. Clients up to 45 years old gain from 1 to 8 inches in a few weeks!

No Appliances—No Drugs—No Dieting. ROSS SYSTEM NEVER FAILS. Fee Ten Dollars Complete. Convincing Testimony and Particulars 5 cent stamp. Allow time for return mails across the Atlantic. G. MALCOLM ROSS, Height Specialist, Scarborough, England. (P. O. Box 15).

First in 1907
First To-day

Autocrat Auto Radio \$17.45

6 TUBE
175 to 550 Meters

Complete less "B" Batteries But Plus Tax

Complete accessories include mounting brackets, illuminated dial, lock switch, remote control, dynamic speaker, 6 RCA (Lisc.) Tubes, spark suppressors, and antenna. Everything except "B" Batteries. Small and compact 5 1/2" x 6 1/2" x 8 1/2". Distance range 100 to 1000 miles. No catalog available. Send \$2.00 deposit. Balance C.O.D.

AUTOCRAT RADIO CO., Dept. R.C.
3855 N. Hamilton Ave. Chicago, Ill.

SERVICEMEN-DEALERS

Write for our Catalogue
Complete Stock of NEW
Radio Replacement Parts

Hard to Get Parts—We have them. Send us your repair work for estimate.

Grant Radio Laboratories
6521-C South Halsted St., Chicago, Ill.

Free

You cannot possibly afford to be without this valuable book. It is not just another CATALOG—it is indeed a VERITABLE ENCYCLOPEDIA of the RADIO INDUSTRY.

WHOLESALE PRICES

All that is New in Radio is Listed in this 100-Page Money-Saving 1932 FALL EDITION CATALOG

WE ARE HEADQUARTERS FOR Public Address Amplifiers and Installations

You Pay ONE PROFIT! Purchase Direct From the Manufacturer! Our Amazing Low Quotations Will Astound You!

It will pay you to trade exclusively with the house of "Coast-to-Coast" . . . write for your copy of our free catalog today!

COAST-TO-COAST RADIO CORPORATION

123 R West 17th St., New York N.Y.

SEND NO MONEY--

Clip and mail to us the coupon below. We will send you either one or both books through the Express Company for your inspection. You have the privilege of keeping or returning them.

If you want to have a complete set of all Radio Diagrams, both manuals should be in your file.

Both volumes of the OFFICIAL RADIO SERVICE MANUAL will give you the most complete set of circuit diagrams ever published for the Radio Industry. Every Radio Service Man and Dealer should have them available for immediate use in his business. Professional set-builders and amateurs will find them instructive and helpful.

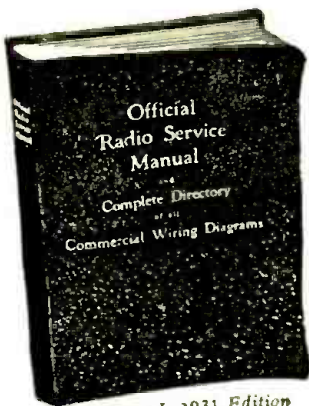

Volume I, 1931 Edition



Volume II, 1932 Edition

Briefly outlined below are the "high spots" that are to be found in the 1931 Manual—the first complete radio service manual ever to be published. Over twenty-seven thousand copies of this edition were sold to members of the radio industry. This assures you of its importance to those engaged in radio and how valuable it is to them.

Partial Contents

Wiring diagrams of radio sets manufactured since 1927, and many earlier ones of which there is any record elsewhere.
650 pages of radio-servicing material.
Complete course of instruction for Radio Service Men, dealers, manufacturers, jobbers, set builders and amateurs.
(Here are but a few of the subjects covered in the special course of instruction).

Amplifiers	Power-Supply Systems
Antennae	Radio Phonograph Equipment
Automotive Radio	Resistors
Condensers	Short-Wave Sets
Detectors	Speakers
Eliminators	Tubes
Meters	

\$4.50 Complete with Supplements

650 PAGES

(Complete with Supplements)

Over 1,500 Diagrams, Charts and Illustrations

Get Supplements FREE with the NEW 1932 MANUAL

There is so much new material in this Manual, that a Service Man or dealer would be lost without it when called to service a set. Information about new models which have been on the market only a few weeks are contained in this book. The 1932 Manual makes the service kit complete.

The 1932 Manual contains a Full Radio Service Guide and a Complete Directory of all 1931-1932 Radio Diagrams, also models of older design. Everyone in the Radio business should have a copy. Send for yours today!

Partial Contents of Volume II

A step-by-step analysis in servicing a receiver which embodies in its design every possible combination of modern radio practice; it is fully illustrated and thoroughly explained. It is the greatest contribution to the radio service field.

Chart showing the operation of all types of vacuum tubes, whether new, old or obsolete. An exclusive resumé of the uses of the Pentode and Variable-Mu Tubes and their characteristics.

Complete discussion of the superheterodyne and its inherent peculiarities. Also a special chapter on tools used on superheterodyne circuits. Schematic diagrams and circuits complete with color codings.

Important chapters on commercial aircraft radio equipment; new data on commercial short-wave receivers and converters.

Servicing and installation of public address systems and talking machine equipment.

Standardized color-codings for resistors.

Operation of old and new testing equipment; tube voltmeters, output meters, oscillators and aligning tools.

A full section on Midget radios—their design, circuits, and types. How to service them most economically. Hundreds of schematic diagrams of older radio receivers which have never been published.

Blank pages for recording notes, diagrams and sketches; these pages are transferable to any part of the book. Coupon page for free questions and answers.

\$5.00 Complete with Supplements

OVER 1,000 PAGES

(Including Supplements)

Over 2,000 Diagrams, Charts and Illustrations

Flexible, Looseleaf Binder, 9 x 12 inches.

CLIP COUPON AND MAIL TODAY!

GERNSBACK PUBLICATIONS, Inc.
96-98 Park Place, New York, N. Y.

HC-10

Please send me for FREE inspection the books I have checked below. I understand I may examine them carefully, and should I decide to keep them, I will pay the full cost, plus the few cents for carrying charges. This offer is good only in the U.S.A.

Volume I, 1931 Manual, with Supplement, \$1.50.

Volume II, 1932 Manual, with Supplements to be mailed Free every 60 days, \$5.00.

BOTH BOOKS FOR \$9.00.

Name

Address

City State

NOT ONE OF THE DIAGRAMS PUBLISHED IN VOLUME NUMBER I OF THE OFFICIAL RADIO SERVICE MANUAL IS REPEATED IN VOLUME NUMBER II.

ADAPTERS FOR TEST EQUIPMENT

(Continued from page 217)

214, 533, 534, 535, 536, 538, 540 and 597. The adapter is to be inserted in a 2.5 volt five-hole socket.

No. 955G-2, Fig. 17, is for testing the Majestic G-2-S and G-4-S tubes in the following tube checkers: Models 209, 210, 214, 533, 534, 535, 536, 538, 540, 597 and 675.

No. 975, Fig. 18, is for testing the types 36, 38 and 39 tubes in the 209 and 210 Jewell tube checkers.

No. 949PT, Fig. 19, is an output meter adapter for use in connection with Jewell 560 and 563 oscillators. Also used with the 444 and 660 set analyzers.

No. 954DS, Fig. 20, changes over a four-prong plug to a five-prong plug. Used with Jewell 444 or any set analyzer having a basic five-prong plug using the Na-Ald latch-lock feature.

No. 944FFL, Fig. 21, is for testing the Kellogg "overhead heater" type tubes in the Jewell set analyzer comprising models 198, 199, 408, 409, 444, 577, 578, 581 and 660.

No. 954KGL, Fig. 22, is for testing the first section of a Triple-Twin tube. This adapter is to be placed in a four-hole socket of the tube tester; the 45 socket for the 295, and the 71A socket for the 293. May be used with analyzer models 209, 210, 214, 533, 534, 535, 536, 538, 540, 597 and 675.

No. 954KG, Fig. 23, tests the second section of the triple-twin tube. May be used in all the analyzer models listed for the No. 954KGL; operating directions are the same as for the No. 954KGL adapter.

No. 944PLCR, Fig. 24, is for testing the type 866 tube in tube checkers. This adapter incorporates a resistor to limit the plate current to prevent damage to meters. May be used with models 209, 210, 214, 533, 534, 535, 538, 540, 597 and 675. Insert in 2.5 volt socket.

No. 965PG, Fig. 25, will also test the types 41, 42, 1A and 1Z11 tubes. However, it is necessary to use the socket of the tester ordinarily used for testing the type 37 tube, or any five-hole socket wired for 6.3 volts.

No. 965-55, Fig. 26, is used for testing the 55 and 85 "duplex-diode triode" tubes. Place in a 27 socket to test the 55 and in a 37 to test the 85. May be used with the following Jewell analyzers: Models 209, 210, 214, 533, 535, 536, 538, 540, 597 and 675, to check the 55 tube.

No. 955GGKL, Fig. 27, is for testing the five-prong Wunderlich "A" tube in the type 27 socket of testers. May be used with all Jewell instrument models described in connection with the No. 965-55 adapter.

No. 965GG, Fig. 28, is used for testing the types 29 and 69 tubes. When testing the 29, use a 2.5 volt (filament) socket; when testing the 69, use a 6.3 volt, five-prong socket. May be used with the following Jewell Models: 210, 214, 533, 534, 535, 536, 538, 540, 597 and 675.

No. 944BRR, Fig. 29, is used to test the Raytheon type BR tube which is made for use in auto "B" eliminators. It is to be placed in the type 80 socket of tube checkers. Included in the adapter is a current-limiting resistor of correct size. May be used with Jewell instruments: Models 209, 210, 214, 533, 534, 535, 536, 538, 540, 597, and 675.

This practically completes the data on adapters suited to the needs of Service Men who own Jewell test instruments; also, it concludes the first part of our article on Adapters. The author will be pleased, indeed, to hear from radio men who may wish to question any of the statements that have been made, or who would like to obtain any additional information regarding the design or use of these very useful units.

THE CRAFTSMAN'S PAGE

(Continued from page 238)

The writer knows of a number of instances wherein the one-ampere detector tubes have been substituted for the older types designed for the 1 1/2 ampere drain; furthermore, in nearly every instance where such procedure has been followed in the case of an old receiving set it has been possible to substitute a second tube of the new type in place of one of the old type 26 tubes (usually the first A.F. tube), and operate the heating feature of same from the filament supply winding of the detector tube without causing perceptible excess heating in the transformer. (Adapters do the trick; or the sockets may be changed, where necessary.)

With the above mentioned facts as a basis for further consideration of the subject I submit that it would be a profitable venture for the tube interests to offer, at an early date, a tube of the 27 type, designed to operate from the 1 1/2 volt winding of transformers intended for type 26 tube supply, and with a drain of not to exceed the one-ampere demand of the present tubes, and also a screen-grid tube operating on the same current drain.

As a matter of information the writer had, at one time, some tubes of the heater type which were designed for operation on a 1 1/2

volt supply circuit and which operated very satisfactorily for a long time.

C. M. DELANO,
Lincoln, Neb.

(Although the proposal of Mr. Delano will strike a responsive chord in the hearts of many, we question whether mathematical computation could stand the strain of supplying identification figures!)

At any rate, Mr. Delano has opinions—and that, certainly, is worth writing home about.

Since the ice has been broken, let us put on record the following suggestions: A line of direct-heater tubes to be known as the "portable series." It should include tubes of screen-grid, pentode and general-purpose type, but with an envelope no larger than is used for the Western Electric type N (No. 215-A) or "peanut" tube, which is the size of one's little finger; their filament is rated at 0.25-amp, and 1.1 volts—the proposed series should more nearly approximate our present "2-volt" series (60 ma. and 2 volts), or perhaps be designed for 1.1 volts supply but a current consumption of only 60 ma., or less.

What say—manufacturers, experimenters, engineers and Service Men?—*Editor.*)

THE "K" TUBE

(Continued from page 206)

milliamperes when ionization took place, and for this reason a limiting resistor must be used to prevent the self destruction of the tube.

The connections for the operation of a relay in a photoelectric cell circuit are shown in Fig. 3 using a single stage set-up of the type "K" tube. A limiting resistor of 3,200 ohms was used in the plate circuit while a 50,000- and a 15,000-ohm potentiometer were used to obtain bias for the grid. The potentiometer was used to set the operating bias. The grid leak to be used depends entirely on the photoelectric cell used, although, as in all gas content tubes, one to two megohms appear to be the maximum practical values. The relay used need not be sensitive, as from 20 to 30 milli-

amperes is available for operation. If more is necessary, it is obtainable by increasing the plate voltage. It is necessary to shunt the relay with about one microfarad of capacity in order to operate on the pulsating current.

Operation was secured on light inputs to the photoelectric cell of much lower intensities than with any previous amplifier tried. In fact, the single stage here proved to be the equal of the two stage direct-coupled amplifier described in the October, 1931 issue of RADIO-CRAFT. The action was very positive, the relay closing with a snap.

Absolutely no chatter could be obtained in any case, even at the threshold of relay operation.

Train Now for New RADIO Opportunities

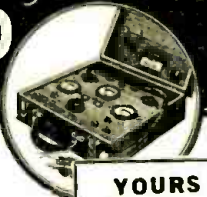

Get Into a Line Where There's Action—

Every Day—And a Pay-day Each Week — You Be the Boss!

YOURS without extra cost. This excellent set analyzer and trouble shooter included with our course of training.

Right now while hundreds are looking for work where there isn't any, the radio service field can use trained men. With the proper training and the necessary equipment you can enter this field and make a comfortable living. We include with our course this modern set analyzer and trouble shooter without any extra charge. This piece of equipment has proved to be a valuable help to our members. After a brief period of training, you can take the set analyzer out on service calls and really count on "old timers." We show you how to wire rooms for radio—install auto sets—build and install short-wave receivers—analyze and repair all types of radio sets—and many other profitable jobs can be yours. Teaching you this interesting work is our business and we have provided ourselves with every facility to help you learn quickly yet thoroughly. If you possess average intelligence and the desire to make real progress on your own merits, you will be interested.

ACT NOW—MAIL COUPON

Start this very minute! Send for full details of our plan and free booklet that explains how easily you can now cash in on radio quickly. Don't put it off! Write today! Send now!

RADIO TRAINING ASSN. of AMERICA
Dept. RCA-10, 4513 Ravenswood Ave., Chicago, Ill.
Gentlemen: Send me details of your Enrollment Plan and information on how to learn to make real money in radio quick.

Name
Address
City..... State.....

A New SHALLCROSS Combination Multi-Range

A.C. and D.C. Meter



using Type No. 610 Shallcross Resistor Kit and the Weston Model 301 Universal Meter.

This Combination Meter measures

- 4 D.C. Voltage Ranges
- 4 A.C. Voltage Ranges
- 4 D.C. Current Ranges
- 3 Resistance Ranges
- 3 Impedance Ranges

including Capacity, Inductance and a High Resistance Range.

Send 6c in stamps for Bulletin 152-P which contains a diagram of this circuit and information on its construction.

Shallcross Mfg. Company
ELECTRICAL SPECIALTIES
700 PARK AVENUE
Collingdale, Pa.

10 NEW BOOKS in the Radio-Craft

Presented on these two pages are the new books of the RADIO-CRAFT LIBRARY—the most complete and authentic set of volumes treating individually, important divisions of radio. Each book has been designed to give radio men the opportunity to specialize in one or more of the popular branches of the industry. The material contained in these books will increase your

knowledge; you will find them a real help in your work and they will contribute to your money earning capacity. Read these books during your spare time at home.

The authors of these books are well-known to everybody. Each one is an expert radio man; an authority on the subject—each is thoroughly familiar with the field which he represents.

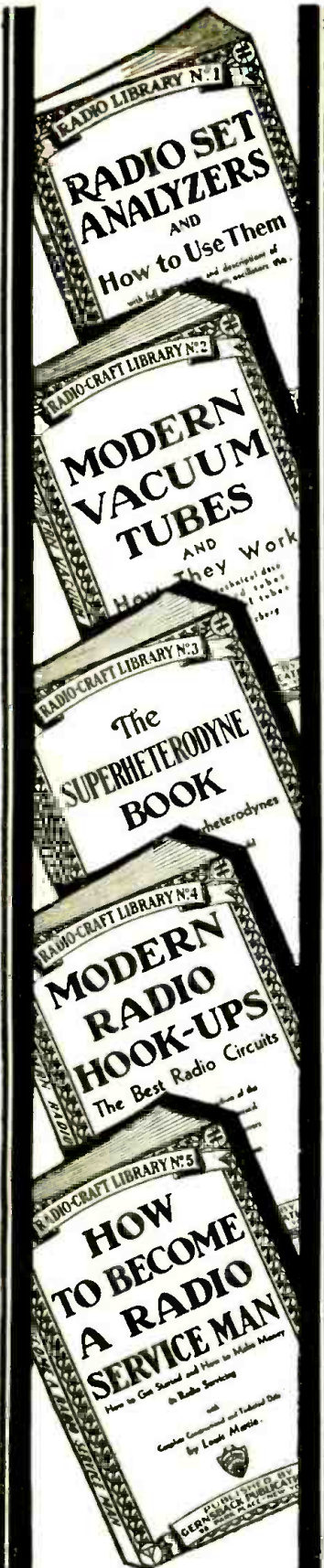

Book No. 1
RADIO SET ANALYZERS
 And How to Use Them
 With Full Instructions and Descriptions of Set Analyzers, Tube Checkers, Oscillators, Etc.
 By L. VAN DER MEL

This book explains thoroughly the operation of set analyzers, tube checkers, oscillators and other testing equipment. For every radio man this book is extremely helpful. It covers every phase of testing and gives you valuable short cuts; completely illustrated with photographs and diagrams to facilitate the use of modern testers.

The following chapters briefly outline the contents: INTRODUCTION; THE ANALYZER; Fundamentals, Switches, A.C. and D.C. Voltmeters, Calibration and Design; TROUBLE SHOOTING WITH THE ANALYZER; Classification of Trouble, Analysis of Troubles, Uses of Various Analyzers, Care and Maintenance; CONCLUSION.

Book No. 2
MODERN VACUUM TUBES
 And How They Work
 With Complete Technical Data on All Standard and Many Special Tubes
 By ROBERT HERTZBERG

MODERN VACUUM TUBES describes the fundamental electron theory which is the basis of all vacuum tube operation, and goes progressively from the simplest two-element tubes right up to the latest pentodes and thyratrons. It is written in clear, simple language and is devoid of the mathematics which is usually so confusing. Valuable reference charts and characteristic curves of standard and special tubes are to be found, also diagrams of sockets and pin connections.

Here are some of the chapters: The Edison Effect and The Electron Theory; Electron Emitters and the Ionization Effect; The Three-Electrode Tube; Vacuum Tube Characteristics; Four- and Five-Element Tubes; Light Sensitive Cells and Other Special Tubes.

Book No. 3
THE SUPERHETERODYNE BOOK
 All About Superheterodynes
 How They Work, How to Build and How to Service Them
 By CLYDE FITCH

There is no more fascinating a subject in the large array of radio circuits than the famous superheterodyne circuit. Whether you are a Service Man or experimenter, first-hand knowledge about the construction of superheterodyne receivers is very important. The book on Superheterodynes gives underlying principles of their construction, right from the very first set made.

The following is a short list of contents: Basic Principles of the Superheterodyne; The Oscillator; First Detector; Single Dial Tuning Systems; Intermediate Amplifier; Second Detector; Audio Amplifier and Power Supply; Commercial Superheterodyne Receivers; Servicing Superheterodynes.

Book No. 4
MODERN RADIO HOOK-UPS
 The Best Radio Circuits
 A Complete Compendium of the Most Important Experimental and Custom-built Receivers
 By R. D. WASHBURNE

It is fascinating to the experimenter, or even to the up-to-date Service Man, to take a commercial set and to change it into one using a famous hookup that is not found in any manufactured set. Many excellent circuits have never been commercialized, but limited only to home-set builders. Thousands of these popular circuits have been requested from time to time, and in this book we have included over 150 circuits, which include the famous Perdyne, Cash-Box A.C.-D.C. Set and others.

The circuits cover the following: Broadcast Receivers, All-Wave Receivers, Short-Wave Receivers, Converters and Adapters, Television Receivers, Home Recording Apparatus, Automobile Receivers, Audio and Power Amplifiers, Power Units and Miscellaneous Equipment.

Book No. 5
HOW TO BECOME A RADIO SERVICE MAN
 How to Get Started and How to Make Money in Radio Servicing
 By LOUIS MARTIN

The ambition of many men in radio today is to become a first-grade Service Man. It is not as difficult as one might believe, but it cannot be done in a few short months. Following very carefully the advice of Mr. Martin, who has dealt with the problems of thousands of Service Men, this book deals very carefully with the essential stages in the preparation for qualifying as a Service Man.

Here are the chapters: The Small Independent Service Man; Advanced Commercial Aspects; The Radio Set; Semi-Technical Considerations; Advanced Service Data. Each chapter is again subdivided to bring out in minute detail every point of importance.

Book No. 6
BRINGING ELECTRIC SETS UP TO DATE
 With Pentodes, Multi-Mus, Dynamic Speakers—Complete Information How to Modernize A.C., D.C. and Battery Operated Receivers
 By CLIFFORD E. DENTON

In this country there are over ten million electrically operated receivers that could be modernized—by placing in them new type tubes, new speaker equipment and other modern improvements. This business of improving old sets can go to the experimenters and Service Men if they will quickly jump into action.

Read in this book by Mr. Denton, how easily you can modernize any obsolete set, and with little additional costs. Here are the high lights of this book: Tubes Available for Replacements; Electrifying Battery Receivers; Use of the New 2- and 6-Volt Tubes; Operating Sets with Single Control; Conversion of A.C. Sets into D.C. and D.C. into A.C.; Replacing Output Tubes with Higher Output Tubes; Improving Old Supers; Lofting White Amplifiers; Adapters and Their Use.

Book No. 7
RADIO KINKS AND WRINKLES
 For Service Men and Experimenters
 A Complete Compendium on the Latest Radio Short-Cuts and Money-Savers
 By C. W. PALMER

It often becomes necessary for experimenters and Service Men to rattle upon their memory for some short cut or radio wrinkle that will solve a problem quickly. In business, "short cuts" mean time and money saved, and to the Service Man "time saved" means money earned.

This book is a compilation of important radio kinks and wrinkles and discusses only such items as are constantly used today. Here are some of the more important chapters: Introduction; Servicing Short-Cuts; Testing Equipment and Meters; Vacuum Tubes and Circuits; Volume-control Methods; Amplifiers and Phonograph Reproducers; Power Supply Equipment; Coils and Tuning Circuits; Short Waves; Loud Speakers; Tools and Accessories.

Book No. 8
RADIO QUESTIONS AND ANSWERS
 A Selection of the Most Important of 5,000 Questions Submitted by Radio Men During the Course of One Year
 By R. D. WASHBURNE

There have been collected a wide variety of questions which have come into our editorial offices during the past two years, and only those whose answers would benefit the majority of men engaged in radio have been incorporated in this amazing question and answer book.

The tremendously long list of topics better explains the subjects which are treated. Here are the titles:

Radio Servicing; Receiver Design; Home Recording; Television; Sound Equipment; Short Waves; Antennas; Operating Notes; Test Equipment; Tubes; Ultra-Short-Waves; Police Radio; Reproducers; Superheterodynes; Automotive Sets; Power Packs; Automatic and Remote Control Devices; Aligning Procedure; Photoelectricity; Adapters; Measuring Apparatus; Band-Selectors; Converters; Public Address Equipment; Midset Sets; Oscillators; Phonograph Pickups.

Book No. 9
AUTOMOBILE RADIO AND SERVICING
 A Complete Treatise on the Subject Covering All Phases from Installing to Servicing and Maintenance
 By LOUIS MARTIN

Automobile radios are on and coming, and someone has to service them properly. It therefore behooves you to read this immensely important new book on the art of Automobile Radio. The book is concise, and full of illustrations, photographs, diagrams and hookups.

Here are only a few of some of the really interesting chapters: Introduction; Automotive Radio Installations; Complete Descriptions of Commercial Automotive Receivers; Servicing Automotive Receivers; The Ignition System; General Service Considerations; Effects of Temperature on Power Supply; Conclusion.

Clip Coupon and MAIL!

GERNSBACK PUBLICATIONS, INC. 96-98 Park Place, New York, N. Y.

I have circled below the numbers of books in the RADIO-CRAFT LIBRARY, which you are to send me, and have deducted 20% for ordering five (5) books or more. I have included my remittance in full, at the price of 50c each, when less than five books are ordered.

The amount of my remittance is _____ (Stamps, checks or money orders accepted.)

Circle numbers wanted: 1 2 3 4 5 6 7 8 9 10

Name _____ Address _____

City _____ State _____ RC-10-32



Library

This is perhaps the first real opportunity that you have ever had to build a radio library of books that are authentic, right-up-to-the-minute and written so that they are easily digested and clearly understood. Mail coupon on the opposite page for your books.

Book No. 10
HOME RECORDING AND ALL ABOUT IT

A Complete Treatise on Instantaneous Recordings, Microphones, Recorders, Amplifiers, Commercial Machines, Servicing, etc.

By GEORGE J. SALIBA

If there is one subject that is fascinating to every radio man, it is that of Home Recording. Of course, this volume is not all on "Home" recording, but the information contained therein is important to commercial radio men, studio operators, engineers and others interested in this phase of radio.

The art of recording and reproducing broadcast selections is becoming more important every day to radio men, experimenters and Service Men. Equipping dance halls, auditoriums, churches, restaurants and homes with public address and amplifiers brings many extra dollars and often an excellent income.

In this book are found such topics as: Short History of the Art; Microphones; Recording Amplifiers; Cutting Heads; Types of Records; Commercial Machines; Adding Recorders to Receivers; Studio Layouts; Mechanical Filters for Turntables.

BIG DISCOUNT OFFERED

In order to make it possible for everyone to buy these books, the fifty (50) cents price has been made uniform for all volumes. You can buy these books separately, but you should take advantage of our special offer:

When Five (5) Books or More Are Ordered Deduct 20% from Your Remittance

Simply fill in the coupon below, and mail it to us together with your remittance. Checks, stamps or money orders accepted.

All Books Uniform

The books in the new RADIO-CRAFT LIBRARY are all strictly up-to-date, and written by men who know their subjects. The volumes are all uniform size, 6 x 9 inches, and contain on an average of 50 to 120 illustrations. Each book is printed on fine book paper, and no expense has been spared to make it an outstanding value, for its editorial contents as well as from the mechanical standpoint.

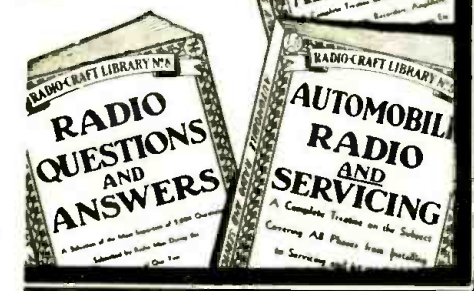

N.R.I. PRACTICAL LABORATORY TRAINING COURSE

This supplementary laboratory course will prove invaluable to the radio student regardless of the branch of the business in which he intends to specialize, as the basic principles underlying the fields of servicing, television, sound pictures, aircraft radio and commercial operating are the same. For example, the sound projectionist, just as well as the Service Man, must understand the operation of vacuum tubes and the resting of circuits, and both must have a thorough understanding of the generation and control of electricity.

The course is divided into five sections of ten experiments each. The first section starts with the simple detection of electric currents by means of an earphone, and proceeds through the following further tests: to show how the presence of an electromotive force can be detected by the eye; to show that an e.m.f. has polarity; to show that a magnetic field is always associated with current flow; to show that a greater magnetic field is produced by direct current flowing through a coil wound on an iron core than by the same current flowing through an air core coil, to show the different conductivities of different materials; to illustrate the effect of electro-magnetic induction; to show how electricity is generated by chemical action; to show the action of the storage battery; to show mechanical generation of electricity.

The second booklet deals specifically with vacuum tubes, how to test them and how to record their behavior under various conditions of filament, grid and plate voltage. The construction of several simple but useful tube testing instruments is described and illustrated.

In the third installment the student is taken into the more advanced subjects of the generation of low-frequency oscillations, the control of frequency, the dynatron oscillator, the modulated R.F. oscillator, the phenomenon of resonance, etc.

The subject of detection or "demodulation" is treated at length in the fourth booklet. Various types of detectors and detector circuits are considered and the features of each described. An excellent modulated oscillator can be made with the apparatus furnished to the student of the course.

The fifth and last booklet expands generally on the subjects previously covered. The usefulness of the vacuum-tube voltmeter is explained, as are numerous methods for using it. The experiments cover the following subjects: the action of the A.F. output transformer; audio amplification with transformer and resistance-capacity coupling; building a regenerative receiver; adding R.F. amplification; and the effect of tuning the aerial circuit.

This course is well prepared and clearly written, and is altogether devoid of the mathematics that confuses many practical radio workers.

HOME EXPERIMENTS

(Continued from page 234)

which you are conducting the experiment, will be sufficient to cause a minute electrical current to flow and register upon the meter. However, when the full force of the rays of a flashlight are flashed on the cell, a decided deflection of the meter needle will be observed, denoting the fact that due to a chemical action within the cell an appreciable electrical current has been caused to flow in the photoelectric cell circuit. To demonstrate how variations in the size and intensity of the beam of light can change the current flow in the cell circuit, it is suggested that the experimenter cut various sized holes in a piece of cardboard and then shine the light from the flashlight through them, noting the while, the change in current indicated on the meter. Also, pieces of smoked glass of varying density may be held before the beam of light to cause changes in the flow of current. Other experiments will suggest themselves to the experimenter. The practical knowledge to be gained from this rather simple experiment is in the parallel which can be drawn between it and the rather elaborate processes involved in the production of sound from film as used in talking movies.

Next month: A simple photo cell and amplifier which may be used to demonstrate variations in sound from an interrupted light source.

SPECIAL

"Pay-as-you-go" OFFER

HERE is a new, practical, plan by which you can start AT ONCE to become a

TRAINED CHEMIST

graduated by our Institute, without the obligation of signing up in advance for your entire course.

By taking only one step at a time—as your means permit—you can give yourself the benefit of the most complete, thorough-going, up-to-the-minute education for skilled well-paying professional work, in the most fascinating of all scientific fields, through our famous

COURSE IN PRACTICAL CHEMISTRY

Our course will give you an all-around, applied training in both the theory and practice of Chemistry—including inorganic and organic Chemistry, quantitative and qualitative analysis.

Under this new plan you pay only for lessons you order and receive at one time.

HERE IS THE IDEA:

\$6.25 pays for one unit of our Practical Chemistry Course.

(The entire course comprises twenty units)

You may order as many units at a time as your purse and your spare time permit.



Size of Cabinet: Height, 22½", Length, 17½"; Weight 25 lbs.

Over one hundred Chemicals and Apparatus

When you have completed the first five consecutive units of your course, and order your sixth unit, our valuable chemical experimental laboratory outfit, (illustrated above) will be sent you free of charge.

We suggest that you try out Unit No. 1. Mail the coupon and start your training as a chemist. You will receive by return mail the first group of lessons of our Course in Practical Chemistry, with full two months' service.

CHEMICAL INSTITUTE OF NEW YORK, Inc.

Founded 1921

HOME EXTENSION DIVISION

19 Park Place

New York, N. Y.

CHEMICAL INSTITUTE OF NEW YORK, Inc.
19 Park Place, New York, N. Y.

Please send me at once Unit No. 1 of your Course in Practical Chemistry. I shall receive full two months' service in grading of my examinations, and the help of your instructors for the understanding of any problems pertaining to the particular lessons.

Please send me the first unit of your Course C. O. D., I will pay the postman \$6.25 (plus postage) upon delivery.

FOREIGN AND CANADA, REMIT BY INTERNATIONAL MONEY ORDER

Name

Address

City..... State.....

HC-10-32

HERE IT IS!

HOW TO BECOME AN

AMATEUR RADIO OPERATOR

We commissioned Lieut. Myron P. Eddy, U. S. Navy, Retired, to write a book on this subject that would answer EVERY possible question in such a way as has never been done before. We chose Lieut. Eddy because his long years of experience in the amateur field have made him pre-eminent in this line. For many years he was instructor of radio telegraphy at the R.C.A. Institutes, and in this capacity he obtained a vast knowledge and insight on the subject. He is a member of the I.R.E. (Institute of Radio Engineers), also the Veteran Wireless Operators' Association.

If you intend to become a licensed code operator, if you wish to take up phone work eventually, if you wish to prepare yourself for this important subject—this is the book you must get.

This book covers literally everything from "soup to nuts" on the subject, in such a clear and lucid manner that it will be of great value to every student.

50¢ THE COPY

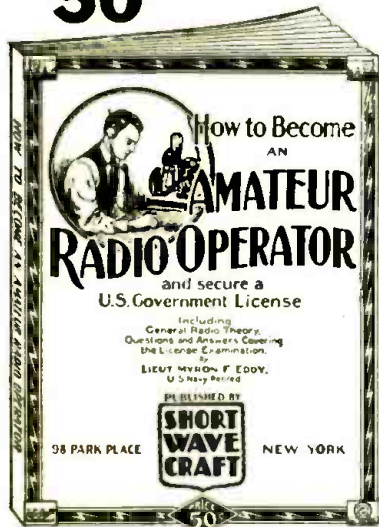

72 Pages

Over 150 Illustrations

Not Sold on Newsstands

Partial List of Contents

CHAPTER 1. Ways and means of learning the code. A system of sending and receiving with necessary drill words is supplied so that you may go right to work on approved methods.

CHAPTER 2. Concise, authoritative definitions of radio terms, units and laws, brief descriptions of commonly used pieces of radio equipment. This chapter gives the working terminology of the radio operator. All graphic symbols used to indicate the various parts of radio circuits are shown so that they may be readily recognized when studied in the following chapters.

CHAPTER 3. General radio theory particularly as it applies to the beginner. The electron theory is briefly given, then waves—their creation, propagation and reception. Fundamental laws of electric circuits, particularly those used in radio, are explained next and typical basic circuits are analyzed.

CHAPTER 4. Descriptions of modern receivers that are being used with success by amateurs. You are told how to build and operate these sets, and how they work.

CHAPTER 5. Amateur transmitters. Diagrams with specifications are furnished so construction is made easy.

CHAPTER 6. Power equipment that may be used with transmitters and receivers, rectifiers, filters, batteries, etc.

CHAPTER 7. Regulations that apply to amateur operators.

CHAPTER 8. Appendix, which contains the international "Q" signals, conversion tables for reference purposes, etc.

SHORT WAVE CRAFT,
98R Park Place, New York City.

Gentlemen:

I enclose herewith 50c for which please send me prepaid, a copy of your new book, "How to Become a Radio Amateur and Secure a U. S. Government License," the book to be sent to me immediately upon publication. (Send Money Order, Check, Cash or new U. S. Stamps. Register letter if it contains currency or stamps.)

Name.....
Address.....
City..... State.....

CLASSIFIED ADVERTISEMENTS

CHEMISTRY

BECOME A TRAINED CHEMIST. Thousands of opportunities—fascinating career. Learn at home. Complete experimental laboratory outfit given. Write for big free book. Chemical Institute, 19 Park Place, Dept. RC, New York.

INSTRUCTION

MEN—Learn to service Electric Refrigerators. Jobs open. Big opportunity. Write for booklet. National Tech. 4306 Euclid Ave., Cleveland, O.

EXCELLENT Money in Public Address work—system needed in every town—excellent sideline for radioticians, electricians, amateurs, etc. Our home study course gives complete training in theory, construction, and operation of public address systems and sound trucks. Special price—\$3.25 cash, or \$1.75 down and \$1.00 per month for two months. Complete course sent with first payment. Lincoln Engineering Company, 855 South 37th, Lincoln, Nebraska.

INVENTORS

PATENT YOUR INVENTION: Send for FREE book, "How to Obtain a Patent," and "Record of Invention" blank. Ask us about how to protect your ideas. Deferred payment. Victor J. Evans & Co., 620K Victor Bldg., Washington, D. C.

MISCELLANEOUS

SPANISH Representation—Executive of New York export house leaves shortly for Spain to organize, radio department of their Spanish branch. Manufacturers of articles that can be sold in sufficient volume to warrant appointment of sales representatives on commission should communicate with Box RC, Radio-Craft, 98 Park Place, New York City. Shipments and payments can be handled with buyers or through New York office.

RADIO

GUARANTEED MICROPHONE REPAIRS—Any make or model—24 hour service. Stretched diaphragm double button repairs, \$7.50. Others \$3.00. Single button repairs, \$1.50. Write for 1933 Catalog with diagrams. Universal Microphone Co., Ltd., Inglewood, Calif.

TRANSFORMERS REWOUND. varnished, baked, guaranteed, reasonable cost. **SPEAKER REPAIRING,** magnetic \$2.00-\$2.50; dynamic, voice coils, fields, etc., reasonable charges. Clark Bros. Radio Co., Albia, Iowa.

RADIO Service Men Attention—Power transformers, rewound or rebuilt, to your requirements. Meyke Radio Service, 2624 Margaretta, Maplewood, Mo.

LET Us rewind your burned-out magnetic horn and cone units. \$1.25 each. Flora Radio Service, Flora, Indiana.

S. W. LABORATORY

(Continued from page 231)

5,000, 10,000, and 20,000 ohms, thus providing an excellent reading range of 1- to 20 volts. The variation of the proper grid voltage for each resistor is accomplished by the 20,000-ohm potentiometer R3. Needless to say, the accuracy of the reading depends upon the accuracy of the voltmeter resistors to a large extent.

Shown with the diagram is the switch SW3 which is closed during operations. When this switch is open, terminals 15 and 13 are used to test for resistance values. This will be explained in the following section.

The 50-type tubes are used in all the individual units because of their low plate and filament-current consumption. The "A" battery is a 4.5 volt "C" battery. Resistors of 41 ohms are in series with each tube filament.

Tests and Measurements

RESISTANCE: The usual resistance test is good for one particular range of resistance, depending on the size of the battery. A 4.5-volt battery will give useful indications up to 100,000 ohms, but not above that, and none below 1,000 ohms. Increasing or decreasing the battery voltage will result in different satisfactory ranges; but for any one battery voltage there will be upper and lower limitations.

The feature of this unit is that almost any range from 50 ohms to 1 megohm can be easily calculated. The potentiometer R3 provides a means of obtaining a variable voltage from 1 to 20 volts. The meter, MA1, may be connected into any range by connecting, for example, the 10,000-ohm resistor R6 so that the full-scale deflection of MA1 is 10 volts. The potentiometer is now adjusted to give a full-scale deflection. The resistance testing terminals are Nos. 13 and 15 (switch SW3 open).

Suppose that while testing a resistor, the meter MA1 shows a deflection of 5-ma. The applied potential being 10 volts, the total circuit resistance is 20,000 ohms. However, in the voltmeter circuit there is a resistance of 10,000 ohms (R6) and the value of the resistance under test is therefore 20,000 minus 10,000 or 10,000 ohms. The same procedure is followed for any range. Select the range by plugging into the proper resistance. Adjust the potentiometer R3 to give full-scale deflection at that particular range. Read the scale reading of MA1 in milliamperes when testing, and determine the value of resistance as described above.

CAPACITY: The capacity test is not as simple as the resistance test as it will be necessary to first determine the capacity of several condensers and then make a permanent record or graph of the readings.

In this method it will be necessary to know the current drain of the copper-oxide voltmeter (now composed of MA2 and either R11, R12, R13, or R14) at any point. This may be obtained by dividing the applied A.C. voltage reading at any point by the series resistance; for example: The A.C. indication is 75 volts. If the 150-volt A.C. range is desired, a series resistance of 75,000 ohms is required (R13) with the particular rectifier used; therefore, the current taken by the voltmeter is

$$I = \frac{E}{R} = \frac{75}{75,000} = .001\text{-ampere}$$

at that point.

The voltage drop across the condenser is obtained by first reading the line voltage *with* the condenser, then reading the voltage *with* the condenser in series, and finally subtracting the second reading from the first; for example, the voltage E_c across the condenser to be tested may be determined from the relation

$$E_c = \frac{I \times 1,000,000}{6.28 \times f \times C}$$

and the capacity in mf. equals:

$$C = \frac{I \times 1,000,000}{6.28 \times f \times E_c}$$

where E_c is the difference in voltage reading; f , the line frequency; C , the capacity in mf.; and I , the current at the second reading.

where thousands look to find the latest science news, constructional articles for home work-shop and money-making ideas . . .

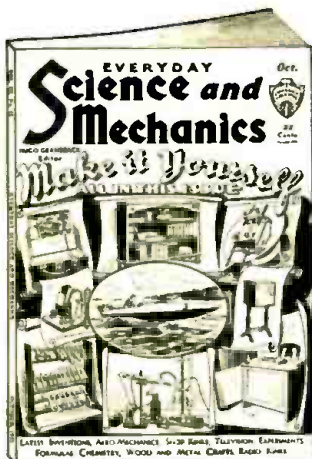

25c
The Copy

Over 450 Illustrations
96 pages—
4-Color Cover
9 X 12 Inches

WE do not hesitate to say that EVERYDAY SCIENCE AND MECHANICS is the finest scientific-technical-mechanical-constructional magazine in the field. Right up-to-the-minute with news flashes of scientific events from all parts of the world. Dozens of constructional articles for making useful things for the shop, garden and home. Many ideas from which you can make things to sell.

Get this magazine at your newsstand today. Read about the many cash prizes which are offered for simple experiments in photography, oddities in science, uses of old auto parts, radio experiments, recipes, formulas and others.

After reading your first issue, you'll agree with us that EVERYDAY SCIENCE AND MECHANICS is all that we claim it to be, and better.

A Host of Interesting Scientific Subjects—

- | | |
|-------------|--------------------|
| RADIO | CONSTRUCTION |
| TELEVISION | METAL WORKING |
| ELECTRICITY | PHYSICS |
| PHOTOGRAPHY | ENGINEERING |
| AVIATION | METALLURGY |
| WOODWORKING | PUBLIC ADDRESS AND |
| AUTOMOBILES | SOUND EQUIPMENT |
| PATENTS AND | HOUSEHOLD AND |
| INVENTIONS | SHOP HINTS |
| NEW DEVICES | AND OTHERS |

SPECIAL OFFER!
8 MONTHS
FOR \$1.00

Clip Coupon and Mail Today!

EVERYDAY SCIENCE AND MECHANICS
100 Park Place, New York, N. Y. RC-10

I enclose herewith One Dollar for which you are to enter my subscription to EVERYDAY SCIENCE AND MECHANICS for the next Eight Months.

Name

Address

City..... State.....

(Foreign or Canadian subscriptions not accepted at this rate.)

Although so many calculations may seem tedious, it must be borne in mind that once they are made, they are permanent. The capacity is, of course, plotted against the second reading. This procedure is the same for any set of frequencies and voltage. The total voltmeter resistance is easily known because if the rectifier is self-constructed, the required series resistor can be measured. Where the rectifier is of commercial manufacture, the series resistors are specified for each range. A manufacturer's curve usually accompanies the rectifier. The particular rectifier used was made so as to utilize the resistances indicated in the wiring diagram. The resistance sizes will vary with each type rectifier, so do not accept the values given as standard.

INDUCTANCE: Having, in all probability, already calculated the current drain of the voltmeter when making the capacity curves, the computations for inductances will be considerably shortened. The procedure for testing inductances is the same as that for capacities. Obtain readings before and after inserting the choke; then calculate the difference. In the case of inductance, the drop across it is due to both the reactance and resistance of the winding. Measure the D.C. resistance of the choke before testing. The formula used to calculate the inductance is:

$$L = \frac{\sqrt{E_1^2 - I^2 R^2}}{I^2 \times f^2 \times (6.28)^2}$$

Where E_1 is the difference in voltage readings; I , the current at any point (second reading); R , the D.C. resistance of the choke; f , the line frequency; and L , the inductance in henries.

POWER: Power measurements may be made by taking a known resistance and obtaining the voltage drop across it. This is an excellent way of computing power output of R.F. and A.F. circuits. For example, let us calculate the power output of the modulator. Connect a 2,000-ohm resistor across the output terminals. Connect the input terminals of the V.T. voltmeter across the resistor. Actually, then, the A.F. output, the resistor, and the V.T.V.M. input terminals are in parallel. First adjust the V.T.V.M. as outlined in its operation procedure; start the modulator and then obtain the D.C. voltage change by varying R_3 ; multiply this by .707 to get the

R.M.S. value. The power output P equals $\frac{E^2}{R}$, where E is the R.M.S. value of voltage.

General Construction

The components have been so arranged that many connections can be made directly to the lugs on the parts themselves. The sockets are placed so direct connections are possible to the condensers or resistors. Since there are a large number of parts within a small space, exact mechanical and physical spacing is necessary. Take the time and care necessary to build a good piece of apparatus. If the copper-oxide rectifier is to be constructed at home, test the individual junctions and choose those having the highest forward-backward resistance ratio.

The simplest manner to make the shunts R_{15} and R_{16} is to wind a length of fine, copper wire, about No. 30 or No. 32, the resistance per foot, for which, may be found from wire tables. Measure the proper length of wire and wind it on any form. Errors of one or two feet in length of wire will be negligible, whereas high-resistance wire must be absolutely calibrated before being used.

Individual shields are placed around the oscillator coil and the tuning condenser. The shield for the condenser is short and constructed so as to fit into the case. Both shields are grounded to the "A—" terminal. The output coil should be wound next to the plate end of the oscillatory tank coil. The spacings for all coils is not critical, being between $\frac{1}{8}$ -in and $\frac{1}{4}$ -in. Contact to the external test posts can be made only by the bi-polar switch. Before testing be certain that the switch is in its proper place.

(Continued on following page)

The TRANSMITTER UNIT
with 100 Uses ~ **95c**

The Skinderviken
Microphone Button

**MAKE YOUR OWN
LAPEL MIKE**

OTHER USES:

RADIO AMPLIFIER PHONOGRAPH AMPLIFIER
DETECTOGRAPH TELEPHONE AMPLIFIER
(Dictograph) LOUD SPEAKER AMPLIFIER
STETHOSCOPE CRYSTAL SET AMPLIFIER

HOME RECORDING OUTFITS

One Unit 95c; two for \$1.75
12-PAGE INSTRUCTION BOOKLET
containing suggestions and diagrams for innumerable uses, furnished with each Skinderviken Button.

This is the smallest microphone made, measuring only $\frac{3}{4}$ inches in diameter. It is filled with the finest polished carbon grains obtainable.

— ULTRA SENSITIVE —

EVERY AMATEUR SHOULD HAVE TWO OR THREE OF THESE MICROPHONE-AMPLIFIERS IN HIS LABORATORY

SEND NO MONEY

When the postman delivers your order you pay him for whatever you have ordered, plus postage.

PRESS GUILD, Inc., RC-10-32
16 Murray St., New York, N. Y.

Please mail me at once as many of the following Skinderviken Microphone Buttons as I have indicated.

- One for 95c;
 Two for \$1.75;
 Three for \$2.50;
 Four for \$3.20

I will pay the postman the cost of the items specified plus postage.

Name

Address

City..... State.....

BOOK BARGAIN

Special Sale of

2000

**S. GERNSBACK'S
RADIO ENCYCLOPEDIA**
1st Edition

WE have on hand 2000 UNBOUND copies of this valuable book, and we are disposing of same at a price which does not even cover the cost of the paper and printing. The books are in first-class condition, sewed and stitched but unbound. You can put a cover on yourself or your bookbinder can do it at a very small expense.

This indispensable radio reference book contains over 1,930 definitions, 549 photo reproductions, drawings, and diagrams. The size of the book is 9 by 12 inches. It contains 168 pages, and is printed on the finest book paper obtainable. Practically every definition in the book is illustrated, and all the subjects are arranged in alphabetical order with numerous tables and charts distributed throughout the text.

PRICE PER BOOK, 69 CENTS

Do not send any money. We will send you the book and you pay the postman 69c plus postage. Cut out coupon, paste on postal card, and mail to:

ISKOR PRESS, Inc., 19 Park Place
New York, N. Y.

BARGAIN ORDER BLANK

ISKOR PRESS, Inc.
19 Park Place
New York, N. Y.

Please mail me S. Gernsback's Radio Encyclopedia, 1st Edition, Unbound. I will pay Postman 69c plus postage.

Name

Address

City..... State.....

HEADQUARTERS
FOR MATERIALS
AND PARTS
FOR BUILDING
Electrical and Radio
**TREASURE
LOCATORS**



Radio, Audio, Ground Potential measurements, Hughes Induction Balances and other types; Oscillators and amplifying systems included.

We supply all materials needed for building and operating any of the recognized treasure finders. The following standard circuits are described in our bulletin:

- No. 1. Ground Potential, Leap-Frog Method.
- No. 2. Hughes Induction Balance Type A
- No. 3. Hughes Induction Balance Type B
- No. 4. Sensitive Hughes Induction Balance
- No. 5. Simple Super-Sensitive Hughes Balance Circuit
- No. 6. Radio Frequency Oscillator Circuit
- No. 7. Audio Oscillator Circuit
- No. 8. Single Search Coil Hughes Induction Balance with Audio Amplifiers
- No. 9. Combination Radio Transmitter and Receiver circuit.

Also accessories such as High Frequency Buzzers, Audio Oscillators, Differential Current Transformers, Two Stage Audio Amplifiers, etc.

With all this apparatus you can locate buried treasures, metal war relics, mineral deposits, subterranean water veins, buried gas and water pipes, and lost objects, tools and treasures sunken in water, etc.

Write for pamphlet giving history and theory on this interesting subject. All above circuits are described and explained. List of parts and prices included. (Price of pamphlet 10c.)

REACTIVATOR

(Continued from page 221)

in your tube checker. If it is not then O. K., return it to the rejuvenator and flash high voltages to the grid and plate while still using 5 volts on the filament. First flash the grid by pressing switch SW2 a number of times, then flash the plate by pressing switch SW1 a number of times. When the desired color has been produced, press both switches simultaneously a number of times and then test the tube in the tube checker. If the tube does not now show a desired improvement, then flash at higher voltages. Flashing must be done by very short, snappy contacts until the desired color is obtained, hence the need of especially quick-acting switches.

As a general rule, the 600-volt tap is used only on type 70 tubes, except after having definitely proven that 400 volts will not do the work; of course, 1,200 volts are used only on 70 tubes. Higher voltages can be used on transmitting tubes, from two to three times their maximum plate operating voltages being required. This is being done at some amateur stations.

If flashing is continued after the blue-green color has arrived, this color will grow weaker and so will the tube.

A large percent of '26 tubes will come back to full life faster than probably any other type of tube, and this is well, for they are the "weak sisters" among the A.C. tubes.

The '12 and '71 tubes will not rejuvenate by this method on account of the type of filament, but '12A and '71A respond readily.

As may be noted by reference to the photographs, only a single 4-prong socket is mounted in the rejuvenator; an additional adapter is used for 5-prong tubes, as shown in Fig. 4. The circuit diagram of Fig. 1 shows connections for the use of two sockets. Merely leave one out if an adapter is to be used.

(The following results were obtained in tests conducted by RADIO-CRAFT:

Practical test of	Before (in ma.)	After (in ma.)
1 '80	25	50
8 '24	3-5	5-10
1 '12A (not '12)	3-4.5	5-10
1 '71A (not '71)	15-17	20-25
1 '35	dead	6-10
4 '26	dead	par
6 (as specified on a Weston test unit)	20-0	20-6
1 '10	40-3	40-8

List of Parts

One power transformer, either special wound or any having 2.5, 5, and 7.5-volt filament windings and 750 or more volts on the H.V. secondary, at 100 ma.;
One four-hole tube socket;
One five-hole tube socket;
Two four-point rotary switches, SW3 and SW4;
One A.C. toggle switch, SW5;
Two special switches SW1 and SW2;
One A.C. voltmeter, 0-7½ volts (not absolutely necessary);
Two phone tip jacks;
One metal or wood box;
Five feet of double light-cord and plug;
One bakelite panel, 7 x 8 in.

TUNING METERS

(Continued from page 240)

When used in R.F. or I.F. amplifier circuits, they may be connected as in the sketch of Fig. 2. They are connected in the plate return lead of four tubes, the normal plate current of each being about 1 ma. If such is the case, the full scale reading of the meter should be about 5 ma, so as the signal reduces the plate current, the pointer travels toward zero. In other words, the full scale deflection of the meter should equal the sum of all the currents of all the tubes which pass through the meter.

In the case of the grid-leak and grid-condenser detector, the range of the meter should be about 1 ma, since the reading decreases as the applied signal increases, similar to the case of amplifiers with A.V.C.

REFLEX RECEIVER

(Continued from page 239)

- One Trutest 4-prong plug, 26A;
- One Trutest Full-Vision Dial;
- Two Trutest Equalizers, capacity 2 to 35 mmf. 7A, 17A;
- One Trutest Binding Post, 1;
- One Amperite Self-Adjusting Line Voltage Control, type 5A-5, 33;
- One I.R.C. (Durham) 500-ohm Metallized Resistor, ¼ watt, type M.F. 4½, 14;
- Two I.R.C. (Durham) 25,000-ohm Metallized Resistors, 1 watt, type M.F. 4, 13, 24;
- One I.R.C. (Durham) 1 meg. Metallized Resistor, 1 watt, type M.F. 4, 19;
- One Arcturus type 56 Tube, 23;
- One Arcturus type 58 Tube, 10;
- One Arcturus type PZ Pentode Power Output Tube, 4;
- One Arcturus type 180 Full Wave Rectifier Tube, 28;
- One Aluminum Chassis, 1/16-in. material, 10 x 6 x 2-in. high;
- One Wright-DeCoster No. 255 Dynamic Reproducer with 2,500-ohm field and output transformer to match PZ or '47 Power Tube, 27.

Mail Coupon TODAY!

GREN PARK COMPANY Dept. RC-10
245 Greenwich St., New York, N. Y.

Enclosed find 10c for which kindly send me pamphlet on Treasure Finders.

Name

Address

State

S. W. LABORATORY

(Continued from preceding page)

Parts List

- Two megohm grid leaks, R1, R19;
- One 50-ohm resistor, R2;
- One 20,000-ohm potentiometer, R3;
- Two 1,000-ohm resistors, R4, R11;
- One 5,000-ohm resistor, R5;
- Two 10,000-ohm resistors, R6, R8;
- One 20,000-ohm resistor, R7;
- One 100,000-ohm resistor, R9;
- One 500,000-ohm resistor, R10;
- One 6,500-ohm resistor, R12;
- One 75,000-ohm resistor, R13;
- One 300,000-ohm resistor, R14;
- One 333-ohm resistor, R15;
- Two 3 1/3-ohm resistors, R16, R17;
- Three 41-ohm resistors, R18, R20, R21;
- One 30-ohm resistor, R22;
- One 1-megohm resistor, R23;
- One audio transformer, any make, ratio 3 to 1, T1;
- One input push-pull transformer as described; A.F.1;
- One R.F. choke as described, R.F.C.;
- One copper-oxide rectifier;
- One .00006-mf. fixed condenser, C1;
- One .00005-mf. variable condenser, C2;
- Three .0001-mf. fixed condensers, C3, C4, C5;
- One .002-mf. fixed condenser, C6;
- One .02-mf. fixed condenser, C7;
- One .005-mf. fixed condenser, C8;
- One .2-mf. fixed condenser, C9;
- One .1-mf. fixed condenser, C10;
- One S.P.D.T. Toggle switch, SW1;
- Two S.P.S.T. Toggle switches, SW2, SW3;
- One 10 point bi-polar switch, SW4;

• Index to Advertisers •

A	
Alden Mfg. Company	242
American Technical Society	240
Amperite Corporation	241
Arco Tube Company	236
Autocrat Radio Mfg. Co.	243
B	
Burstein-Applebee Co.	242
C	
Cable Radio Tube Corp.	Inside front cover
Candler System	240
Central Radio Laboratories	243
Chemical Institute	247
Claroostat Mfg. Company	238
Classified Section	248
Coast-to-Coast Radio Corp.	243
Coyne Electrical School	193
F	
Flanders Hotel	254
G	
Gernsback Corporation, S.	242
Gold Seal Mfg. Company	234
Grant Radio Laboratories	243
Grenpark Company	250, 253
H	
Hoodwin, Company, Chas.	242
I	
International Correspondence Schools	239
International Resistance Company	233
Iskor Press, Inc.	249
J	
J M P Mfg. Company	234
L	
Lincoln Radio Corporation	200
Lynch Mfg. Company	238
M	
McGraw-Hill Book Company	237
Midwest Radio Corporation	199
Montclair Hotel	254
N	
National Radio Institute	196, 197
New Bismark Hotel	254
P	
Peerless Radio Parts Company	242
Popular Book Corporation	240, 248
Press Guild, Inc.	249, 251
R	
Radio Receptor Co.	242
Radio Trading Company	255
Radio Training Association of America	245
Radolek Company	243
Readrite Meter Works	235
Ross, G. Malcom	243
Ross Press	236
S	
Scott Radio Labs., Inc. E. H.	195
Shalleross Mfg. Company	245
Supreme Instruments Corp.	Back cover
T	
Triad Mfg. Company	Inside back cover
U	
United Radio Service	238
Universal Microphone, Ltd.	242
W	
Williams & Son, J. R.	241

(While every precaution is taken to insure accuracy, we cannot guarantee against the possibility of an occasional change or omission in the preparation of this index.)

OPERATING NOTES

(Continued from page 225)

which was covered with rosin. The tip of a hot iron soon remedied this condition.

This bad joint rendered the control-grid circuit of the A.V.C. tube open, thus causing the tube to draw so much plate current as to pass an excessive control-grid bias on the tubes which it controlled, producing the effect as described.

General Motors 252, etc.

A large number of General Motors model 252 receivers, a ten-tube superheterodyne, have been serviced because of an annoying, intermittent buzz-buzz that rode in, at regular intervals, above the signal level. As the tubes checked perfectly and the interference ceased when the aerial and ground wires were disconnected and the local distance switch was set at local, shorting aerial and ground, it appeared that the noise was external. But after listening to several receivers in the same building, where no interference of this nature was picked up, it was evident that the buzz-buzz was caused by a tube or some part of the set. Each tube was substituted with one from the kit and when the first-detector '24 was replaced, the interference was ended! The original tube had responded satisfactorily to all meter tests, yet, had caused the receiver to be noisy.

Of the four '24 tubes carried in the kit that were tried in this stage, another was found that produced the same noise. Because of the design of this receiver, it is essential that a tube of the correct characteristics be used as the first-detector.

Brunswick 42

The automatic mechanism of the phonograph part of the Brunswick 42 combination, though relatively simple, still furnishes cause for complaint. In some cases, it was found that as soon as the record had been lowered into position and the pickup head had come down upon the records, the mechanism rejected the record before it was played and then another record was lowered, after which this sequence of actions was repeated.

This is usually caused by the cycle switch, whose blades or contacts do not open when the cycle is ended. It is only necessary to loosen the two screws holding this switch in position and adjust the switch so that the contacts will disengage at the correct moment.

This same defect will not permit the phono mechanism to be switched off, without pulling out the line plug and the mechanism will continue to reject until this is done.

On other occasions, the mechanism will not reject the records, but repeats the same one. This is due to the fact that the contacts on the small switch (that travels along with the tone-arm) do not open because they have been set too close together. Here, these contacts must be so adjusted that when the tone-arm and pickup head reach the end of the record, the plunger or trigger of the switch will open the contacts when the former engages with the stop. Either the stop will have to be brought in further by loosening the screw and re-setting, or the tension on the spring contact must be reduced by loosening the two nuts on the screw that controls the tension.

Automobile Interference

Many paragraphs have been written upon the suppression of noise in automotive radio receivers, but there still arise cases, where everything known has been tried with little success. It is quite possible that this interference may be eliminated by having the motor and all wires and parts beneath the hood thoroughly cleaned and washed, especially the wires. Just this, has eliminated noise that for many weeks had been combatted without any results.

The grease and oil as well as road-dust, covering the wires and motor, contain a certain percentage of carbon and graphite which will cause many high-frequency leaks and losses, increasing noise and impairing motor performance.



3 Valuable New Books

Formulas and Recipes Radio — Mathematics

Presented here are three brand new books, of diversified nature, which are most educational and instructive. Each book carefully treats a subject in full, and is prepared by an expert in the field. The books are well written and thoroughly illustrated to make the contents easily learned. Get these books promptly—mail coupon below.

1. FORMULAS AND RECIPES for the Practical Man

This book has been compiled by S. Gernsback, a well-known author of practical instructional manuals in various scientific fields. It is extremely helpful and will show you how to save money by making in your own home, at a fraction of the regular cost, the hundred and one preparations which you now buy for use at home or business.

HERE ARE PARTIAL CONTENTS:

1. Adhesives; Glues, Cements. 2. Cleansing: Stain Removers, Bleaches. 3. Metal Craft: Coloring, Oxidizing, Plating, Polishes. 4. Paints: Colors, Stains, Varnishes. 5. Glass-Working: Cutting, Drilling, Boring, Etching, Engraving. 6. Wood-Craft: Finishing, Acid-proofing, Waterproofing, Furniture Polishes. 7. Inks: Sympathetic, Invisible, Hectograph. 8. Photography: Developers, Emulsions, Fixers. 9. Antidotes for Poisons, Remedies for Burns and Scalds, Disinfectants. 10. Preparation, Manipulation, Handling, Mixing, Tables of Weights and Measures, Useful Tables.

2. FUNDAMENTAL PRINCIPLES OF RADIO Radio Simply Explained—Its Origin, Nature and Functions

The book, written by Louis Martin, has been prepared with special consideration given to young members in the radio profession, and those who have gained their experience in a haphazard fashion. This radio primer is a handy fundamental aid for "checking up" and systematizing your knowledge of radio. Regardless of how much you know about the subject, you should read this book.

HERE ARE PARTIAL CONTENTS:

Chapter I—Fundamentals of Radio: Electricity, Resistance, Batteries, The Magnetic Circuit, The Magnetic Field, Inductance, Condensers, A.C. Circuits, Propagation of Radio Waves; Chapter II—The Simple Radio Set, Single, Two, and Three-Circuit Tuners, The Battery Set, Vacuum Tubes, Electric Sets, Loud Speakers; Chapter III—Diagrams, How to Read Them; Chapter IV—Amateurs and Broadcast Stations, Talking Pictures, Television.

3. ELEMENTARY MATHEMATICS for the Technician and Craftsman

This manual has been especially prepared for the man who wishes to acquire a working knowledge of the elementary principles of mathematics. A complete treatment of the subject is given by the author, Mr. C. Shainmark, with special attention to the use of mathematics in Radio and other technical work for those who employ its formulas daily.

HERE ARE PARTIAL CONTENTS:

I—Arithmetic: Addition, Multiplication, Subtraction, Division, How to Use Decimals; II—Fractions, Percentages, Ratio and Proportions; III—Powers and Roots; IV—The Metric System; V—How to Measure Surfaces and Volumes; VI—Mathematics for the Manual and Technical Craftsman; VII—Special Mathematics for the Radio Technician; VIII—Commercial Calculations, Short-cut Arithmetic, Interest Calculation, Discounts; IX—Weights and Measures; X—Useful Tables.

All our books are of uniform size, 6 x 9 inches, and contain 64 pages. The books are printed on strong paper with stiff colored covers.

Clip and Mail Coupon TODAY!

PRESS GUILD INC., 16 Murray St., New York City, R.C. 10

Enclosed find \$.....for which mail me the following books:

No. 1
No. 2
No. 3

50c each, Postpaid.

Name
Address
City and State.....

A NEW FREE SERVICE

Booklets that will be mailed to you free if you send in coupon below

67. RICH REWARDS IN RADIO

No one can read this heavy 64-page book, printed throughout in two colors, without realizing that the radio field is a rich and large one. It points out in convincing fashion that there are many opportunities in set servicing, broadcasting, commercial radio operating, aviation, radio and television, and it describes the excellent courses of home instruction in these subjects that the National Radio Institute has available to ambitious men of all ages. Dozens of testimonials scattered throughout the book indicate that the instruction is highly successful in training capable radio experts. *National Radio Institute.*

58. THE UPPCO A.C. CAR GENERATOR

The problem of furnishing power to the automobile radio receiver or portable public address amplifier has been attacked from several angles by interested manufacturers. The general trend seems to be toward the use of the car's regular storage battery for filament supply and of "B" batteries, rotary converters and vibrator type power units for plate supply. However, the manufacturers of the Uppco Car Generator go a step further and provide a double generator which replaces the present charging generator in the car and supplies six volts D.C. for regular automotive purposes and also 110 volts, 60 cycles A.C. for radio purposes. With this power supply, the advantages of standard A.C. receivers, amplifiers and associated equipment may be enjoyed with a minimum of operating trouble and expense. The generator is available in three models, having outputs of 100, 150 and 300 watts, respectively. The possibilities and advantages of the arrangement are obvious. *Upp Electric Company.*

69. ARCO PHOTO CELLS AND TELEVISION LAMPS

The increasing importance being assumed by photo-electric cells for a wide variety of radio, electrical and industrial applications makes it desirable for Service Men and experimenters to develop a close acquaintance with them, for eventually they will encounter them in their everyday work. For this reason the Arco bulletin is worth reading, as it contains some readable "dope" on the caesium type cell and includes a hook-up showing how it is used. The back of the sheet also includes a handy reference list of some 60 tubes, many of which are no longer considered

Radio-Craft READERS' BUREAU

On this page are listed booklets, catalogs, pamphlets, etc., of Manufacturers, Schools, Institutions, and other organizations, which may be of interest to readers of "Radio-Craft." The list is revised each month, and it will be kept as up-to-date and accurate as possible. In all cases the literature has been selected because of the valuable information which the books contain.

This Service is absolutely free to all Readers of "Radio-Craft."

Fill in and mail the coupon below; make sure that your name and address are included and are plainly written. Order by number only.

standard and cannot be obtained from other sources of supply. *Arco Tube Company.*

70. NOISE-REDUCING ANTENNAS

This four-page reprint of an article on noise-reducing antennas for short-wave reception is very interesting and contains a lot of how-to-do-it material that will be appreciated by practical Service Men and short-wave fans. It deals with the use of special aerials of the so-called "doublet" type, with transposed-wire lead-ins or "feeders" which themselves do not act as aerials but serve only to connect the actual aerial to the receiver. Since much of the noise that affects short-wave reception is picked up by the ordinary lead-in (because of its proximity to electrical ma-

chinery in buildings), this arrangement is noticeably quieter than conventional antenna systems, and is therefore well worth installing in notoriously noisy districts. *Lynch Mfg. Co.*

71. BRUNSWICK REPLACEMENT PARTS

Service Men who have occasion to repair Brunswick receivers, which were widely distributed at one time, will be glad to learn that replacement parts for some sixteen models are now available from a reliable organization. This firm has published a seven-page list of conveniently indexed parts, for the following Brunswick model numbers: 14, 21, 31, S-14, S-12, S-31, 15, 22, 32, 42, 11, 12, 16, 33, 17, 24 and 25. The number of each part, a description of it and its price are all given. *United Radio Service Co.*

72. FOX IMPROVED SOUND EQUIPMENT

The three technical bulletins covered by the name above are of special interest to individuals or firms engaged in public address or theatre sound system work. The first describes a new all-aluminum trumpet horn and an adapter which permits two or three horns to be used with one dynamic unit. The second describes a heavy duty electro-dynamic speaker unit having a capacity of 25 watts. The last bulletin describes various exponential horns for theatre and other indoor uses. *Fox Electric and Manufacturing Co.*

73. AUTO DIAL RADIO

This folder describes a powerful auto radio receiver using a '47 pentode and having an output rating of 2½ watts. It uses regular A.C. tubes of the 24, 35 and 27 varieties, which are easily replaceable at low cost. The speaker is of the full dynamic type. The whole outfit is unusually compact and may be installed with a minimum of tool work on the car itself. *J-M-P Manufacturing Company.*

74. THE LINCOLN DE LUXE 33

Radio men who have become slightly fed-up on tiny midgets which have just enough parts to make them produce signals will read this description of the Lincoln Model 33 receiver with relish. Here is a 12-tube all wave receiver, tuning from 15 to 550 meters, with all the features that advanced radio engineering technique has made possible at the present time. It is a superheterodyne, of course, with automatic volume control, visual tuning, twin grid detection, double push-pull audio, etc. *Lincoln Radio Corp.*

RADIO-CRAFT	67-74
Readers Bureau	
96-98 Park Place, New York, N. Y.	
Please send me free of charge the following booklets indicated by numbers in the published list above:	
No.
Name
Address
City.....	State.....

"Round the World" Reception!

World wide reception with the new "Powertone" battery operated shortwave receiver is an accomplished fact. Letters from enthusiastic customers verify the fact that they have received more distant stations on this receiver than on any other two or three tube receiver.

It requires no exaggeration to create enthusiasm for the new "Powertone" two tube short wave receiver. The "Powertone" short wave receiver handles the broadcast band as well as the short waves. Price complete with set of matched tubes. Set of full sized batteries for above receiver.

It's fine construction (which includes a main .00015 Hammarlund condenser) gives you complete assurance of dependable round the world performance throughout the years to come.

The tubes used in this receiver are 1-232 and 1-233 which are used advantageously and economically in this receiver.

The tuning range of the "Powertone" receiver is from 14 meters up to broadcast band with plug-in type coils.

RC 504A Our Price \$9.95
RC 504B Our Price 12.50
3.50

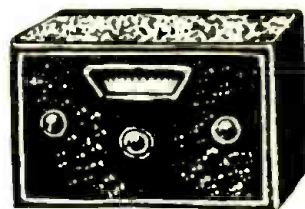

OXFORD DYNAMIC SPEAKER CHASSIS

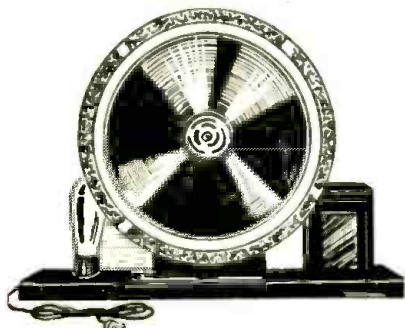

Oxford Speakers are constructed to give reproduction as near perfect as possible—they have long been known to give radio's finest tone qualities. The most advanced principles of speaker design for dynamics have been incorporated in Oxford Speakers. Those that bear recognition are: the three-point suspension balance; permanitized controlled diaphragm; moisture-proof coil mountings; and inertia counteracted construction.

A.C. Models—14" Auditorium Speaker, using 280 rectifier..... No. RC 177—\$10.00
12" Concert Dynamic, using 280 rectifier, No. RC 178— 8.50
9" Midget Dynamic, using 280 rectifier, No. RC 179— 7.50
D.C. Models — 14" Speaker, 5000 ohm field No. RC 180— 8.95
11" Speaker, 2500 ohm field No. RC 181— 4.95
9" Speaker, 2500 ohm field No. RC 181— 2.45
All 9" Midgets are supplied with hum balancer.

POWERTONE DIRECT COUPLED AMPLIFIERS

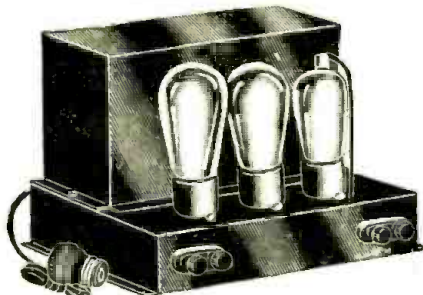

All the latest features in amplifier design have been incorporated in this direct coupled amplifier. Input terminals for permitting phonograph attachment, and in addition, by attaching the proper microphone transformer, also dry cell batteries, a microphone may be used for public address work. Any type of receiver can be connected to the input terminals without fear of loss of energy. These amplifiers are for use with dynamic speakers.

Amplifiers supply field current of 2500 ohms to dynamic speakers. Resistors are furnished when D.C. speakers are used. Amplifiers operate on 110 volts, A.C., 60 cycles.

Model RC 245 uses 1—224, 1—245 and 1—280 Output is rated at 3 watts.

No. RC 245—Our Price \$10.95 (less tubes)

Exactly the same amplifier, but employs a power pentode in place of the 245 tube. Output is rated at 2.5 watts.

No. RC 246—Our Price \$12.95 (less tubes)

Model RC 250 uses 1—224, 1—250 and 1—281. Consumption is 85 watts; maximum undistorted output, 6 watts. Gain rated at 100 cycles, 55db; gain at 1000 cycles, 52.5 db; gain at 10,000 cycles, 51.5. Input direct to 224 control grid; output direct from 250 plate.

No. RC 250—Our Price \$15.25 (less tubes)

JENSEN DYNAMIC SPEAKER CHASSIS

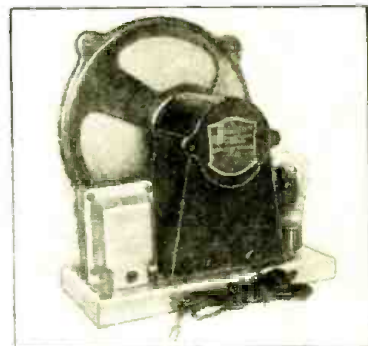

The tone and quality of these reproducers are unsurpassed. Will reproduce faithfully under the most trying conditions. These speaker outputs are available for all new type tubes as well as the old.

A.C. Types, D-7 Jr. Auditorium (as pictured) uses 280 rectifying tube in conjunction with 8 mfd. electrolytic condenser which insures minimum hum.

JENSEN—
A.C.—D-8 Dry Rectifier.....No. R 184—\$14.95
A.C.—D-7 Jr. Audit. Tube Rectifier.....No. R 185— 9.95
A.C.—D-15 Concert Jr. Tube Rect.....No. R 186— 7.50
D-9—2500 Ohm D.C. Field.....No. R 187— 6.95
D-7—2500 Ohm D.C. Field.....No. R 188— 7.50
D-15—Midget, 2500 Ohms.....No. R 189— 4.75

FARRAND INDUCTOR DYNAMICS

Farrand Inductor dynamic, the finest speaker available anywhere for A.C., D.C., or battery operated sets.

Will take as much power and reproduce in tone and quality as the finest dynamic speaker will.

In buying a FARRAND INDUCTOR DYNAMIC you are making a safe investment, because these speakers will match any of the new output tubes as well as all the old type output tubes.

A special feature of the FARRAND INDUCTOR DYNAMIC is that it has a freerating cone, which tends to bring forth the speech and music with true fidelity. Absolutely will not blast or rattle.

Please state type of power or power tubes when ordering.

9 inch model.....No. RC 192—\$5.95
12 inch model.....No. RC 193— 5.95



BALDWIN DYNAMIC CHASSIS



The introduction of the BALDWIN name need not be further discussed.

From the beginning of Radio, Baldwin has been a pioneer in radio reproducing equipment. We need no further praise in recommending a Baldwin Speaker for any purpose in regard to radio.

A.C. using 280 Tube Rect., No. RC 410—Our Price \$6.95
D.C. 2500 Ohm—110 Volts, No. RC 411—Our Price \$4.95
D.C. 2500 Ohm—110 Volts Field, Less Stand, No. RC 412—Our Price \$4.00
D.C. 2500 Ohm—110 Volts Field, Less Output Trans., No. RC 413—Our Price \$3.25

R.C.A. VICTOR HAND MICROPHONE



This microphone is furnished with the latest model Radiola 86 Home recording Super-Heterodyne Receiver and Amplifier. Do not confuse this microphone with the "toy" type as it can be used for many professional and commercial uses. It is a single button "mike" with a gun metal finish. Its total length is 6 1/2" and has as standard equipment a four foot cord.

No. RC 417—Our Price \$2.75

Franklin Transmitting Keys and Buzzers Practice Set



For those who want to practice code, sending and receiving, this small practice set is recommended. A small dry cell is required to operate buzzer, otherwise it is complete.

No. RC 300—Key only, 95c
No. RC 301—Buzzer only, 69c

T.C.A. "OVER-SIZE" INPUT PUSH-PULL AUDIO TRANSFORMER

Enclosed in a fully shielded, highly attractive cadmium plated steel case. Ideal for sub-panel structure mounting, by virtue of the protruding soldering terminals—by employing mounting columns, this unit can also be used for "bread-board" style installation.

A massive unit—measuring 3 1/2 inches x 2 1/2 inches x 3 inches tall. Actually weighs 2 1/2 pounds!

Windings are rendered impervious to moisture. This unit can also be used as an excellent conventional all-stage A.F. transformer.

We highly recommend the use of this highly efficient transformer in public address amplifiers as well as for GENERAL REPLACEMENT PURPOSES!

No. RC 900—Our Price—\$1.35

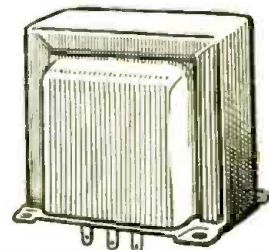

All offers are F.O.B. New York, and subject to prior sale. Terms: A deposit of 20% is required with every order. Balance may be paid on delivery. Or, deduct 2% if full amount is sent with order. Mention catalog number when ordering.

GRENPARK CO., Dept. RC., 245 GREENWICH STREET, NEW YORK, N. Y.

HOTEL DIRECTORY OF THE RADIO TRADE

The Hotels on this page are patronized by the Radio Trade.
Make them your Headquarters.

COMING TO CHICAGO



COME this Fall . . . see the Century of Progress in the making. The Planetarium . . . aquarium . . . Ft. Dearborn . . . and Field Museum are complete. Many more buildings will be finished shortly.

Notice how the Bismarck Hotel is centrally located . . . close to the theatre and shopping districts . . . nearest hotel to the Merchandise Mart . . . and the great Stadium where many conventions are held.

- | | |
|--|--|
| 1. NEW BISMARCK HOTEL
Palace Theatre
Metropolitan Office Bldg. | 10. One La Salle Street Bldg. |
| 2. Merchandise Mart
(Marshall Field Wholesale) | 11. Continental Illinois Bank Building |
| 3. Marshall Field Retail | 12. Central Tr. Co. of Illinois |
| 4. La Salle-Wacker Building | 13. Board of Trade |
| 5. Builder's Building | 14. Illinois Bell Telephone |
| 6. Chicago Temple | 15. Chicago Civic Opera Bldg. |
| 7. City Hall—County Bldg. | 16. Butler Bros. |
| 8. Steuben Building | 17. Adler Planetarium |
| 9. Foreman State Bank Bldg. | 18. Shedd Aquarium |
| | 19. Field Museum |
| | 20. Soldiers' Field |

Inviting, outside rooms . . . comfortable and quiet. Wonderful beds that lull you to sleep . . . silent light signal in your room announces mail . . . soft water for your bath . . . and food that has a reputation the world over. Cheerful service that invites you back.

Rooms with bath, \$3.50, \$4, \$4.50, \$5, and \$6
Rooms without bath, \$2.50

Free to those who answer this advertisement . . . a map of the Central West together with a map of downtown Chicago.

OTTO K. EITEL
Manager

BISMARCK HOTEL

Randolph at La Salle Chicago

Write for booklet with downtown map.



A HOMEY HOTEL IN THE HEART OF NEW YORK

THE NEW FLANDERS

133 W. 47th Street through to 48th Street

One of the Finest Hotels in Times Square

Single Rooms with Adjacent Bath . . . \$1.50 and up
Single Rooms with Bath . . . 2.00 and up
Double Rooms with Bath . . . 3.00 and up
Suite—2, 3, 4 People . . . 5.00

Special Weekly Rates

FRED W. BIZEL, Resident Manager



THE HOTEL

MONTCLAIR

LEXINGTON AVE., 49th to 50th STS.
NEW YORK

Directly Opposite the Waldorf-Astoria

800 ROOMS

Every Room With Bath
From \$3.00 per day

Attractive Rates by the Month

A RADIO IN EVERY ROOM

Short walking distance from Grand Central Terminal and B. & O. Motor Coach Station. Ten minutes by taxi from Pennsylvania Station.

American Home Cooking Served in a Notable Restaurant

OSCAR W. RICHARDS, Manager

FREE!

JUST OUT

Nothing
Like it
in Print

100

New
Hook-
ups

1000

Illus.

100
Pages

YOU
MUST
HAVE
THIS
GREAT
BOOK

ACTUAL
SIZE

8"x9 1/2"

HERE at last is the new **RADIO AND SHORT WAVE TREATISE No. 25**. Considerably larger and more instructive than our No. 24 issue. If you had our Treatise No. 24, you are familiar with the type of book we publish; but the No. 25—what a book! **ENTIRELY**

WRITE TODAY.

Enclose 4c for postage.
Book sent by return mail.

This book is not just another catalog but a veritable mint of radio information which will be of infinite and everlasting value to you.

NEW FROM BEGINNING TO END.
ENTIRE EDITORIAL SECTION IS NEW—
not an old world remains. Considerable space has been devoted to a **COMPLETE TREATISE ON SHORT WAVES**. This alone is worth its weight in gold. All the information necessary for the Short Wave beginner to become a regular "ham" is incorporated in this excellent Treatise. No. 25 IS NOT JUST ANOTHER CATALOG. It contains more valuable and up-to-date information than can be

found in any radio text book on the subject. Among the new technical information listed in this book are the following: Modernizing old radio sets.—Repairing speakers and headphones.—Making superhets out of old T.R.F. receivers.—Constructional data for 2-volt battery receivers and automobile sets.—Constructional data for the famous GERNSBACK "MEGADYNE" ONE-TUBE LOUDSPEAKER RECEIVER.—Short wave coil winding data.—Discussion on short wave adapters, converters, receivers and how to build them.—Amateur transmitters and how to construct them.—Television receivers.—New complete Radio Craft Tube Table.—Numerous radio kinks, etc., etc.

RADIO TRADING CO.

23 WEST BROADWAY

NEW YORK

Announcing

The Pre-Publication Offer of the

1933 Official Radio Service Manual

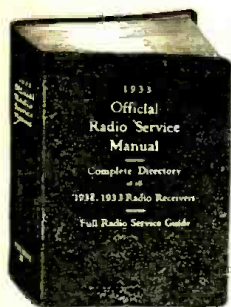

\$4.00

THIS SPECIAL
OFFER IS VOID
AFTER
SEPTEMBER 24th

OVER 2,000
ILLUSTRATIONS

OVER 700 PAGES

9 x 12 INCHES

FLEXIBLE
LOOSELEAF
LEATHERETTE
COVER

The importance of the last two OFFICIAL RADIO SERVICE MANUALS to those engaged in the Radio Industry has been shown by the fact that over 52,000 copies of both editions have been purchased and are in use by manufacturers, jobbers, dealers, Service Men and experimenters. Incessant demands have encouraged us to publish a new and bigger *Service Manual* for 1933.

The new manual will not contain so many full-page illustrations as in the past for the reason that not as many new sets are being put out at present, but will have in its contents important information that has not yet appeared in print. This new "dope" is invaluable to radio men. Stress has been emphasized on giving only practical material, not complicated theory. It is bound to save time and money for everyone.

The simplicity in the makeup of the 1933 Manual makes information easy to find, accurately and quickly. As in the past the size will be 9 x 12 inches, with flexible, looseleaf leatherette cover.

Many additional features will be included in the new manual. The FREE QUESTION AND ANSWER SERVICE which was extremely popular in the previous edition will also be maintained. We assure you that the 1933 OFFICIAL RADIO SERVICE MANUAL will be a revelation in radio literature.

Advanced orders are now being accepted at a most attractive pre-publication price of \$4.00. Immediately upon publication of the new *Manual* this price shall be withdrawn and the Five Dollar sales price shall prevail. Take advantage of this low price—send your order today. Be among the early ones to get a copy from the first printing. Checks or money orders accepted—register letter if it contains cash or unused U. S. Postage Stamps.

The following are partial contents of the 1933 Manual:

Complete operating notes, and hints from actual experience with radio receivers in the field, collected by practical Service Men all over the country.

Complete actual, pictorial views of hundreds of commercial receivers with additional schematic diagrams. Location of parts on the chassis are shown, and where important adjustments must be made. This section alone is worth the price of the book.

Values of all intermediate frequencies used in superheterodynes, and a complete section of valuable service data on superheterodynes.

Values of resistors and condensers, to aid in replacement work.

Latest information on combination long- and short-wave receivers, short-wave adapters and converters.

How to tune and service short-wave receivers for best results.

How to use the most modern servicing instruments.

Complete section showing how the Service Man can build himself service instruments, oscillators, etc., at very low cost.

Complete section on the construction of all test equipment, including high- and low-frequency oscillators, tube checkers, ohmmeters, etc.

Tube-chart information on all new and old tubes, in handy form for quick reference; indicating socket connections and operating values, thereby preventing confusion.

An entire section on money-making suggestions for Service Men, written by the Service Men themselves who have made a success of the business; giving you short cuts and commercial information on how to get the most out of the servicing game.

Servicing information on interference elimination, with practical data and many examples of interference prevention.

Automobile radio installation and servicing—hints on automobile radio in general. Complete data on servicing all known, commercial, automobile receivers with short cuts to get quickly at the seat of the trouble.

Service kinks, servicing short cuts, and miscellaneous servicing information.

A complete section of various radio tables of every imaginable kind, in constant use by up-to-date Service Men.

A large section giving complete technical data on meters of every kind pertaining to servicing in general.

Complete index and cross-index to make it easy for you to find almost anything pertaining to service *instantly*.

FREE
QUESTION
AND
ANSWER
SERVICE

In every copy of the 1933 Manual, 24 coupons will be found, which will entitle you to 24 thorough and complete answers by mail on servicing and operating on any of the sets or circuits mentioned in the manual, as well as any others not mentioned, for which you might have need. This service alone is worth \$6.00. But it is absolutely free to manual owners.

GERNSBACK PUBLICATIONS, Inc.
96-98 Park Place, New York, N. Y.

I am enclosing herewith my remittance of \$1.00 for which you are to send me one copy of the 1933 OFFICIAL RADIO SERVICE MANUAL at the special pre-publication price of \$4.00 each. I understand that the price of the 1933 Manual will be Five Dollars upon publication, when this offer will be void. This offer is void after September 24th.

Name

Address

City..... State..... RC-1032

THE OFFICIAL RADIO SERVICE MANUAL
FOR 1933 COMES TO YOU COMPLETE
THIS YEAR—NO SUPPLEMENTS
MAIL COUPON NOW

OVER-THE-COUNTER SUGGESTIONS

By JACK GRAND

The whistles blew and the bells rang,
And the door opened with a bang.
There was I, leaning "Over the Counter"
Offering suggestions to an old "Brass
Pounder."

Anyhow, a customer came in for an '80 tube and I suggested an 82, because the 82 tube is becoming very popular as a replacement tube for the '80 and '81 types of rectifiers, as it is more efficient than either of these two tubes, especially on heavy drain sets, and is less costly than the latter. However, to obtain best results with this new rectifier, a tube shield is required; also, a small choke of about 2 millihenries, with a current capacity of 250 ma., must be placed in series with the common lead of the power transformer as shown in Fig. 1A. The resistance of the choke must be low; approximately 50 ohms.

When using the 82 to replace the '80 tube, I would suggest that an 8-ohm resistor be used in one of the filament leads to cut the potential to 0.5 volt. Although the current requirement of the 82 is 3 amperes, the filament winding for the '80 will stand the overload.

In the case of the '81 type tubes, the secondary winding must be checked to see that no more than 500 volts is obtained on each half of the winding; then, the filament winding must be checked. If the transformer is made by a good manufacturer, then the 7.5-volt winding will stand the overload; otherwise, I recommend a small 2.5-volt transformer rated at 6 amps. at a cost that will still effect quite a saving. Figure 1B shows how to connect an 82 to replace one '81; and Fig. 1C, two 82's to replace two '81's, both using 7.5-volt windings. If a 2.5-volt transformer is preferred, the resistors shown in the filament winding must be omitted. The 82 tube, a shield and choke were sold. The smiling report next day was, "O. K., Jack!"

In this department Mr. Grand passes on to RADIO-CRAFT readers many new thoughts and ideas he encounters in his daily over-the-counter contact with radio technicians who come from all over the world to one of New York's oldest retail radio establishments.

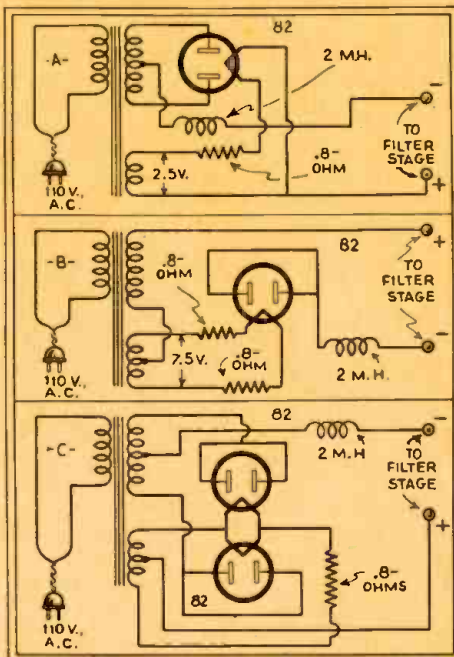

Fig. 1. At A (top) is shown the 82 replacing an '80; B (center), the connections for replacing an '81, and; C (bottom), recommended wiring for replacing two type '81 rectifiers.

Here is a good money making idea for the Service Man who owns an oscillator. Recalibrate radio receivers to read in kilocycles or meters—as most newspapers and radio magazines list the stations. Thousands of set owners, especially those fishing for distance, would like to dial for stations as listed in these periodicals.

It gets hot, a resistor does, particularly if it is placed too close to the base or other objects that will not allow it to dissipate heat, even if the power rating of the resistor is three times what it should be—correct figuring, say some of our good engineers—and others.

The flood of the best toned, longest-distance getting sets, consisting of four and five tubes "built at a price" as high as \$7.95; opens the market again for wave-traps. Some salesman will admit that they are slightly broad near a powerful station. Yes sir! It appears now that all stations are powerful with this type of set.

Mr. S..... who is connected with one of the largest utilities in this country dropped in to say "hello" and at the same time to purchase a 2-watt neon tube. We all know that you can't read a newspaper by the light of a neon lamp so I asked him what he was going to use it for. He told me that an inexpensive method used to determine the efficiency of various tubes in the detector and audio systems is to use a neon lamp. The neon lamp is connected across the output of the receiver. The glow on the plate of the neon lamp will be greater when the more efficient tube is used. In some sets where the amplification is poor, the output transformer should be disconnected for this test. This ought to be good news to some of our thrifty friends.

Improving the radio-frequency stages, when your power tube already overloads, is just like adding another load to the old gray mare when she can't even pull the first load.

== POST CARD ==

PLACE
STAMP
HERE

E. H. SCOTT RADIO LABORATORIES, INC.

Dept. RC10

4450 Ravenswood Avenue

CHICAGO, ILLINOIS

== POST CARD ==

PLACE
STAMP
HERE

SUPREME INSTRUMENTS CORPORATION

1933 Supreme Bldg.,

GREENWOOD, MISS.

== POST CARD ==

PLACE
STAMP
HERE

CABLE RADIO TUBE CORP.

230-242 North 9th Street

BROOKLYN, N. Y.

== POST CARD ==

PLACE
STAMP
HERE

J. E. SMITH, PRESIDENT

National Radio Instituté

Dept. 2KX

WASHINGTON, D. C.

EASILY BUILT 0-800 V. PEAK VOLTMETER FOR RECTIFIER WORK

By J. S. WILLIAMS*

TESTING filter circuits to determine the correct condenser to use involves a consideration of "peak voltages." To measure peak potentials requires either a vacuum tube, an electrostatic voltmeter, or an oscillograph; these are rarely found outside well-equipped laboratories. Here is a simple means of constructing a peak voltmeter which will indicate the peak voltages of the entire filter circuit of any standard radio receiver.

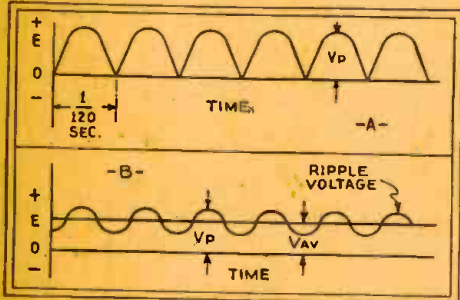

Fig. 1. At A is shown the waveform at the output of the rectifier, and at B the waveshape as it might exist on the first condenser of the filter circuit.

The output of a rectifier is pulsating direct current, as shown at A in Fig. 1. The effect of the filter condensers, imposed across the output, is to smooth out these wave pulsations. At B in Fig. 1 is shown a waveform such as might exist on the first condenser of a filter circuit.

Condensers have a maximum or peak voltage rating. This has reference to the maximum instantaneous voltage, as shown by V_p in Fig. 1A. The peak voltage of the output may be measured by a voltmeter, as shown

*Chief Engineer, Mallory-Elkon Division P. R. Mallory & Co.

in Fig. 2, by adding the average D.C. voltage (V_{av} in Fig. 1B) to the A.C. component, shown by the ripple voltage-line in the same figure.

A D'Arsonval (ordinary D.C.) meter will give the average, or D.C. working voltage. The A.C. component, the R.M.S. ripple voltage, is the R. M. S. value of some A.C. voltage which will give the waveshape in question (ripple voltage) when it is imposed upon a smooth D.C. voltage equal to V_{av} (Fig. 1B). Its frequency is 120 cycles, for a rectifier operating on a 60-cycle input.

Voltages across rectifier circuits naturally vary with the line voltages applied to the set. Line potentials reached in service are sometimes as high as 135 volts. Because of this, voltage measurements in condenser tests would be made with 135 volts applied to the set. Or, if the measurement is simply to determine what voltages the condenser must stand, lower voltages may be increased to an equivalent of 135 volts, by multiplying by the following constants: 110 V., 1.227; 115 V., 1.174; 120 V., 1.125; 125 V., 1.080; 130 V., 1.038.

The maximum voltage ratings of, for instance, Mallory-Elkon condensers are: 450

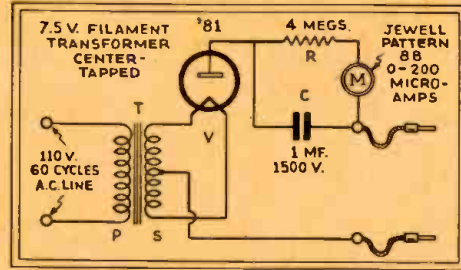

Fig. 2. The connections of the peak voltmeter. The entire voltmeter is easily mounted in a portable case, with cord, ready for service.

volts, D.C.; 475 volts, peak; 25 volts, R.M.S. ripple.

With 135 volts applied to the set, none of these voltages should exceed these values.

The peak voltmeter described here is sufficiently accurate for all test work of this nature. In addition, it is low in cost, easy to construct, and it is usable on either D.C. or A.C. as designed; the range is 0 to 800 volts.

Only five parts are needed, as shown. These are: One 7.5 volt center-tap, filament transformer, T; one '81 type tube, V; one 1 mf, 1500 V. condenser, C; one 4-meg. resistor, R; and a Jewell pattern 88, 0-200 micrometer, M.

(Since the voltage and current in an A.C. circuit are continually varying in value and reversing in direction, it is evident that the equivalent to an equal unit of steady direct current is really some value between the maximum and minimum values of the A.C.

In order to establish the units of alternating voltage and current on a common basis with those of D.C., an ampere in an A.C. circuit is defined as that rate of current flow in an A.C. circuit which will produce heat at exactly the same rate as one ampere of steady D.C. This is the effective or r. m. s. value of the A.C. and is equal to the maximum or peak value multiplied by 0.707 (for a sine-wave potential); also, the effective voltage is equal to 0.707 times the maximum voltage (for a sine wave).

The heating effect of D.C. is proportional to the square of the current (I^2R). If we consider the instantaneous values of current flowing at various intervals during a cycle of A.C., then square them (heating effect), then find the average of these values (average heating effect) and then extract the square root of this average value, it will be equal to the D.C. that will produce an identical heating effect. The effective value of the current obtained in this manner is 0.707 times the maximum value. Since it is the "square root of the average or mean squares" of several current values during one cycle, it is abbreviated root-mean-square, or r. m. s.

This subject is very nicely covered in "Radio Physics Course," by A. A. Gherardi.—Tech. Ed.)

Supreme Instruments Corporation,
1933 Supreme Bldg.,
Greenwood, Miss.

Send me, free of cost or obligation, the 1933 SUPREME SERVICE catalog, now ready.

Name

Address

City..... State.....

Jobber's Name.....

Address

E. H. Scott Radio Laboratories, Inc.,
Dept. RC10, 4450 Ravenswood Avenue,
Chicago, Illinois.

Send me fully detailed technical description of the new Scott Allwave Deluxe.

Name

Address

Town..... State.....

J. E. Smith, President,
National Radio Institute,
Dept. 2KX, Washington, D. C.

Dear Mr. Smith: I want to take advantage of your Special Offer. Send me your Service Manual "Trouble Shooting in D.C., A.C. and Battery Sets" and your book "Rich Rewards in Radio," which explains Radio's Opportunities for bigger pay and your method of training men at home in spare time. I understand this request does not obligate me.

Name

Address

City..... State.....

Cable Radio Tube Corp.,
230-242 North 9th Street,
Brooklyn, New York.

Gentlemen: Please send me current bulletins without charge or obligation on the items checked:

- () SPEED Radio Tubes () SPEED Foto-Lectric Tubes
- () SPEED Television Tubes () SPEED Triple-Twin Group

Name

Address

City..... State.....

"HONOR



"BUILT"

PRICE

Some tubes are sold on low-price alone. Where price is the whole consideration, we can't possibly hope to sell Certified TRIADS, the Double-Checked Tubes, with an engineering pedigree accompanying each tube. The TRIAD certification slip assures the purchaser of positive satisfaction and the dealer of a real profit. In quantities, the discount is 50% to TRIAD Dealers and Servicemen.

QUALITY

Certified TRIAD Tubes are of superior and regular quality. They are all right up to a very high standard. The engineering slip which is sealed in with each tube assures you of absolute satisfaction with a real guarantee. Our story in a nutshell is "there are no better tubes that Certified TRIADS."



PREMIUMS

The announcement made in our "ad" last month practically cleaned out our stock of the \$18.00 Hammond Electric Clocks which we gave free to Certified TRIAD Dealers and Servicemen with their first 50.00 order—\$25.00 net. There are a few left.

We are now able to make another striking introductory offer. By an arrangement with the publishers we now offer a handsome copy of the popular *Official Radio Service Manual* or *Radio Encyclopedia* with each Dealer or Serviceman's initial order of 40.00—\$20.00 net. No radio organization is complete without copies of all these important books. Read the publishers' advertisements which tell you all about them, then send in your first order for



CERTIFIED

TRIAD

TUBES

The TRIAD Line is complete. It includes all types of standard Tubes as well as Photo-Electric Cells Television Tubes.

CERTIFIED TRIAD TUBES are licensed by RCA, and are sold at the same list prices.

TRIAD MANUFACTURING CO. Pawtucket, R. I.

My money order or check for \$20.00 is attached. In return, I want the CERTIFIED TRIAD TUBES listed from the regular TRIAD TUBE list amounting to \$40, less 50% discount. I am also to receive, ABSOLUTELY FREE, the manual checked below:

- 1931 OFFICIAL RADIO SERVICE MANUAL
- 1932 OFFICIAL RADIO SERVICE MANUAL
- 1933 OFFICIAL RADIO SERVICE MANUAL
- S. GERNSBACK'S RADIO ENCYCLOPEDIA

Name
Address
City..... State.....

My letterhead or business card is attached

Presenting

the pictorial
INDEX
to the new
1933

SUPREME
Testing Instruments

CATALOG
Now Ready



No. 56
Set
Analyzer



No. 66 TUBE-O-METER
(Also available with stand)



No. 90 SET ANALYZER



No. 33
Ohmmeter



No. 77
Universal
Analyzer
Converter



SUPREME DIAGNOMETER
● AAAI ●

Seventeen modern testing instruments and combinations of instruments that speed and simplify the science of radio service! The answer to Mr. Modern Radio-Man's demand for "Supreme" engineering leadership in all his equipment . . . a demand born of the brilliant, indelible way the DIAGNOMETER wrote the name SUPREME across the horizon of the radio service world! No matter when you plan to modernize or add to your equipment, send the coupon NOW for the 1933 SUPREME catalog—now ready—and free of cost or obligation.

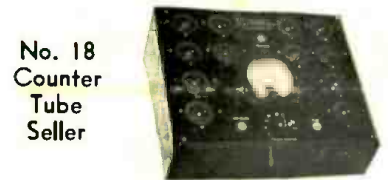

No. 18
Counter
Tube
Seller



No. 88
Leakage
Tester and
D.C. Volt
Meter



No. 75
A.C.—D.C.
Volt-Ohm-
Milliammeter



No. 62
Tube Testing
Power Unit

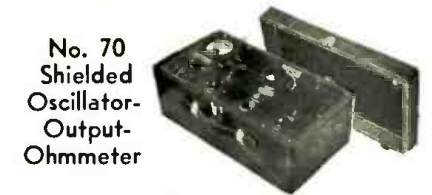

No. 70
Shielded
Oscillator-
Output-
Ohmmeter



No. 44
D.C. Volt-
Ohmmeter



No. 57
Decade
Resistance Bridge

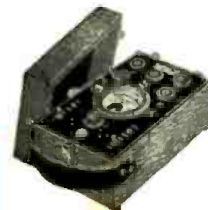

No. 40
Portable
Tube
Checker



No. 60
Handy
Oscillator

SUPREME INSTRUMENTS CORPORATION,
1933 Supreme Bldg., Greenwood, Miss.
Send me, free of cost or obligation, the 1933
SUPREME SERVICE catalog, now ready.

Name _____
Address _____
City _____ State _____
Jobber's Name _____
Address _____